



Contract Number

24-617

SAP Number

Department of Public Health

Department Contract Representative	<u>Michael Shin, DPH Contracts</u>
Telephone Number	<u>(909) 832-0807</u>
Contractor	<u>M3 Group Inc. (DBA Mission Mobile Medical Group)</u>
Contractor Representative	<u>Monica Grashuis</u>
Telephone Number	<u>(775) 741-8777</u>
Delivery Date	<u>No more than 150 Days from Deposit</u>
Original Contract Amount	<u>NTE \$1,299,000</u>
Amendment Amount	<u>N/A</u>
Total Contract Amount	<u>NTE \$1,299,000</u>
Cost Center	<u></u>

IT IS HEREBY AGREED AS FOLLOWS:

WHEREAS, San Bernardino County (County) desires to purchase three mobile health clinics 1 Mobile Health Clinic Dual Medical, 1 Mobile Health Clinic Hybrid Dental/Medical, 1 Mobile Health Clinic Dual Dental) and

WHEREAS, the County conducted a competitive process to find M3 Group Inc. (DBA Mission Mobile Medical Group)(Contractor) to provide these services, and

WHEREAS, the County finds Contractor qualified to build and deliver three mobile health clinics.

WHEREAS, the County desires that such services be provided by Contractor and Contractor agrees to perform these services as set forth below;

NOW, THEREFORE, the County and Contractor mutually agree to the following terms and conditions:

A. DEFINITIONS

- A.1** Clinical Operations (Clinic Ops) – The division within the Department of Public Health responsible for providing a wide range of low-cost, confidential health services. Clinic Ops mission is to protect health, prevent disease, and promote health and well-being.
- A.2** Delivery Date(s) – Date or dates upon which the Goods is to be delivered to San Bernardino County (SBC), Department of Public Health (DPH).
- A.3** Department of Public Health (DPH) – The County department that helps to prevent epidemics and the spread of disease, protect against environmental hazards, prevent injuries, promote and

encourage healthy behaviors, respond to disasters and assist communities in recovery, and assure the quality and accessibility of health services throughout the San Bernardino County.

- A.4** Mobile Health Clinic – A Class A RV mobile vehicle meeting all specifications identified in Attachment C. The term shall include all machinery, equipment, supplies, items, parts, materials, labor or other services, including design, engineering and installation services, provided by Contractor as specified in Attachment C, attached hereto and incorporated herein by reference.

B. CONTRACTOR RESPONSIBILITIES

- B.1** Contractor shall supply County three (3) Mobile Health Clinics meeting all specifications identified in Attachment D that was originally submitted by Contractor with their response to ITB -DPHE24-CO-5354-Class C RV Mobile Health Clinic. Attachment C to this contract recites the required specifications of the Mobile Health Clinic.

- B.2** Contractor shall deliver, Freight on Board (FOB) on Delivery, three Mobile Health Clinics to the County's place of delivery (address below), no later than 150 days from the date of deposit receipt.

LOCATION and ADDRESS To Be Determined
San Bernardino, CA 92415

- B.3** Contractor shall immediately notify San Bernardino County in writing any time delivery is behind schedule or may not complete on schedule as specified in Attachment C.

- B.4** Reserved.

- B.5** Contractor shall provide Operator Certification Course, including classroom instructions, hands on training of setting up and preparing for event and drive mode, safety training, driving, and parking in San Bernardino County.

- B.6** Contractor shall provide Fast Start Coaching (four coaching sessions) to implement a Mobile Healthcare Solutions plan.

C. GENERAL CONTRACT REQUIREMENTS

C.1 Recitals

The recitals set forth above are true and correct and incorporated herein by this reference.

C.2 Contract Amendments

Contractor agrees any alterations, variations, modifications, or waivers of the provisions of the Contract, shall be valid only when reduced to writing, executed and attached to the original Contract and approved by the person(s) authorized to do so on behalf of Contractor and County.

C.3 Contract Assignability

Without the prior written consent of the County, the Contract is not assignable by Contractor either in whole or in part.

C.4 Contract Exclusivity

This is not an exclusive Contract. The County reserves the right to enter into a contract with other contractors for the same or similar services. The County does not guarantee or represent that the Contractor will be permitted to perform any minimum amount of work, or receive compensation other than on a per order basis, under the terms of this Contract.

C.5 Attorney's Fees and Costs

If any legal action is instituted to enforce any party's rights hereunder, each party shall bear its own costs and attorney's fees, regardless of who is the prevailing party. This paragraph shall not apply to those costs and attorney's fees directly arising from a third-party legal action against a party hereto and payable under Indemnification and Insurance Requirements.

C.6 Background Checks for Contractor Personnel

Contractor shall ensure that its personnel (a) are authorized to work in the jurisdiction in which they are assigned to perform Services; (d) do not use legal or illegal substances in any manner which will impact their ability to provide Services to the County; and (c) are not otherwise disqualified from performing the Services under applicable law. If requested by the County and not in violation of applicable law, Contractor shall conduct a background check, at Contractor's sole expense, on all its personnel providing Services. If requested by the County, Contractor shall provide the results of the background check of each individual to the County. Such background check shall be in the form generally used by Contractor in its initial hiring of employees or contracting for contractors or, as applicable, during the employment-screening process but must, at a minimum, have been performed within the preceding 12-month period. Contractor personnel who do not meet the County's hiring criteria, in County's sole discretion, shall not be assigned to work on County property or Services, and County shall have the right, at its sole option, to refuse access to any Contract personnel to any County facility.

C.7 Change of Address

Contractor shall notify the County in writing, of any change in mailing address within ten (10) business days of the change.

C.8 Reserved.

C.9 Compliance with County Policy

In performing the Services and while at any County facilities, Contractor personnel (including subcontractors) shall (a) conduct themselves in a businesslike manner; (b) comply with the policies, procedures, and rules of the County regarding health and safety, and personal, professional and ethical conduct; (c) comply with the finance, accounting, banking, Internet, security, and/or other applicable standards, policies, practices, processes, procedures, and controls of the County; and (d) abide by all laws applicable to the County facilities and the provision of the Services, and all amendments and modifications to each of the documents listed in subsections (b), (c), and (d) (collectively, "County Policies"). County Policies, and additions or modifications thereto, may be communicated orally or in writing to Contractor or Contractor personnel or may be made available to Contractor or Contractor personnel by conspicuous posting at a County facility, electronic posting, or other means generally used by County to disseminate such information to its employees or contractors. Contractor shall be responsible for the promulgation and distribution of County Policies to Contractor personnel to the extent necessary and appropriate.

County shall have the right to require Contractor's employees, agents, representatives and subcontractors to exhibit identification credentials issued by County in order to exercise any right of access under this Contract.

C.10 Confidentiality

Contractor shall ensure that all staff, volunteers and/or Subcontractors performing Services under this Contract comply with the terms and conditions as set forth in the Human Services Information Privacy and Security Requirements specified at <http://hss.sbcounty.gov/Privacy> prior to providing any Services. Contractor shall immediately notify the County of any suspected or actual breach of confidential information as further detailed in the requirements. These requirements specified at <http://hss.sbcounty.gov/Privacy> are hereby incorporated by this reference.

C.11 Primary Point of Contact

Contractor will designate an individual to serve as the primary point of contact for the Contract. Contractor or designee must respond to County inquiries within two (2) business days. Contractor shall not change the primary contact without written acknowledgement to the County. Contractor will also designate a back-up point of contact in the event the primary contact is not available.

C.12 County Representative

The Director of DPH or his/her designee shall represent the County in all matters pertaining to the services to be rendered under this Contract, including termination and assignment of this Contract, and shall be the final authority in all matters pertaining to the Services/Scope of Work by Contractor. If this contract was initially approved by the San Bernardino County Board of Supervisors, then the Board of Supervisors must approve all amendments to this Contract.

C.13 Damage to County Property

Contractor shall repair, or cause to be repaired, at its own cost, all damages to County vehicles, facilities, buildings or grounds caused by the willful or negligent acts of Contractor or its employees or agents. Such repairs shall be made immediately after Contractor becomes aware of such damage, but in no event later than thirty (30) days after the occurrence.

If the Contractor fails to make timely repairs, the County may make any necessary repairs. The Contractor, as determined by the County, shall repay all costs incurred by the County for such repairs, by cash payment upon demand, or County may deduct such costs from any amounts due to the Contractor from the County, as determined at the County's sole discretion.

C. 14 Debarment and Suspension

Contractor certifies that neither it nor its principals or subcontractors is presently debarred, suspended, proposed for debarment, declared ineligible, or voluntarily excluded from participation in this transaction by any federal department or agency. (See the following United States General Services Administration's System for Award Management website <https://www.sam.gov>). Contractor further certifies that if it or any of its subcontractors are business entities that must be registered with the California Secretary of State, they are registered and in good standing with the Secretary of State.

C.15 Drug and Alcohol Free Workplace

In recognition of individual rights to work in a safe, healthful and productive work place, as a material condition of this Contract, the Contractor agrees that the Contractor and the Contractor's employees, while performing service for the County, on County property, or while using County equipment:

- C.15.1** Shall not be in any way impaired because of being under the influence of alcohol or an illegal or controlled substance.
- C.15.2** Shall not possess an open container of alcohol or consume alcohol or possess or be under the influence of an illegal or controlled substance.
- C.15.3** Shall not sell, offer, or provide alcohol or an illegal or controlled substance to another person, except where Contractor or Contractor's employee who, as part of the performance of normal job duties and responsibilities, prescribes or administers medically prescribed drugs.

The Contractor shall inform all employees that are performing service for the County on County property, or using County equipment, of the County's objective of a safe, healthful and productive work place and the prohibition of drug or alcohol use or impairment from same while performing such service for the County.

The County may terminate for default or breach of this Contract and any other Contract the Contractor has with the County, if the Contractor or Contractor's employees are determined by the County not to be in compliance with above.

C.16 Duration of Terms

This Contract, and all its terms and conditions, shall be binding upon and shall inure to the benefit of the heirs, executors, administrators, successors, and assigns of the respective parties, provided no such assignment is in violation of the provisions of this Contract.

C.17 Employment Discrimination

During the term of the Contract, Contractor shall not discriminate against any employee or applicant for employment because of race, religious creed, color, national origin, ancestry, physical disability, mental disability, medical condition, genetic information, marital status, sex, gender, gender identity, gender expression, sexual orientation, age, or military and veteran status. Contractor shall comply with Executive Orders 11246, 11375, 11625, 12138, 12432, 12250, 13672, Title VI and Title VII of the Civil Rights Act of 1964, the California Fair Employment and Housing Act and other applicable Federal, State and County laws and regulations and policies relating to equal employment and contracting opportunities, including laws and regulations hereafter enacted.

C.18 Environmental Requirements

In accordance with County Policy 11-08, the County prefers to acquire and use products with higher levels of post-consumer recycled content. Environmentally preferable goods and materials must perform satisfactorily and be available at a reasonable price. The County requires Contractor to use recycled paper for any printed or photocopied material created as a result of this Contract. Contractor is also required to use both sides of paper sheets for reports submitted to the County whenever practicable.

To assist the county in meeting the reporting requirements of the California Integrated Waste Management Act of 1989 (AB 939), Contractor must be able to annually report the County's environmentally preferable purchases. Contractor must also be able to report on environmentally preferable goods and materials used in the provision of their service to the County, utilizing a County approved form.

C.19 Improper Influence

Contractor shall make all reasonable efforts to ensure that no County officer or employee, whose position in the County enables him/her to influence any award of the Contract or any competing offer, shall have any direct or indirect financial interest resulting from the award of the Contract or shall have any relationship to the Contractor or officer or employee of the Contractor.

C.20 Improper Consideration

Contractor shall not offer (either directly or through an intermediary) any improper consideration such as, but not limited to cash, discounts, service, the provision of travel or entertainment, or any items of value to any officer, employee or agent of the County in an attempt to secure favorable treatment regarding this Contract.

The County, by written notice, may immediately terminate this Contract if it determines that any improper consideration as described in the preceding paragraph was offered to any officer, employee or agent of the County with respect to the proposal and award process. This prohibition shall apply to any amendment, extension or evaluation process once a contract has been awarded.

Contractor shall immediately report any attempt by a County officer, employee or agent to solicit (either directly or through an intermediary) improper consideration from Contractor. The report shall be made to the supervisor or manager charged with supervision of the employee or the County Administrative Office. In the event of a termination under this provision, the County is entitled to pursue any available legal remedies.

C.21 Informal Dispute Resolution

In the event the County determines that service is unsatisfactory, or in the event of any other dispute, claim, question or disagreement arising from or relating to this Contract or breach thereof, the parties hereto shall use their best efforts to settle the dispute, claim, question or disagreement. To this effect, they shall consult and negotiate with each other in good faith and, recognizing their mutual interests, attempt to reach a just and equitable solution satisfactory to both parties.

C.22 Legality and Severability

The parties' actions under the Contract shall comply with all applicable laws, rules, regulations, court orders and governmental agency orders. The provisions of this Contract are specifically made severable. If a provision of the Contract is terminated or held to be invalid, illegal or unenforceable, the validity, legality and enforceability of the remaining provisions shall remain in full effect.

C.23 Licenses, Permits and/or Certifications

Contractor shall ensure that it has all necessary licenses, permits and/or certifications required by the laws of Federal, State, County, and municipal laws, ordinances, rules and regulations. The Contractor shall maintain these licenses, permits and/or certifications in effect for the duration of this Contract. Contractor will notify County immediately of loss or suspension of any such licenses, permits and/or certifications. Failure to maintain a required license, permit and/or certification may result in immediate termination of this Contract.

C.24 Material Misstatement/Misrepresentation

If during the course of the administration of this Contract, the County determines that Contractor has made a material misstatement or misrepresentation or that materially inaccurate information has been provided to the County, this Contract may be immediately terminated. If this Contract is terminated according to this provision, the County is entitled to pursue any available legal remedies.

C.25 Mutual Covenants

The parties to this Contract mutually covenant to perform all of their obligations hereunder, to exercise all discretion and rights granted hereunder, and to give all consents in a reasonable manner consistent with the standards of "good faith" and "fair dealing".

C.26 Nondisclosure

Contractor shall hold as confidential and use reasonable care to prevent unauthorized access by, storage, disclosure, publication, dissemination to and/or use by third parties of, confidential information that is either: (1) provided by the County to Contractor or an agent of Contractor or otherwise made available to Contractor or Contractor's agent in connection with this Contract; or, (2) acquired, obtained, or learned by Contractor or an agent of Contractor in the performance of this Contract. For purposes of this provision, confidential information means any data, files, software, information or materials in oral, electronic, tangible or intangible form and however stored, compiled or memorialize and includes, but is not limited to, technology infrastructure, architecture, financial data, trade secrets, equipment specifications, user lists, passwords, research data, and technology data.

C.27 Notice of Delays

Except as otherwise provided herein, when either party has knowledge that any actual or potential situation is delaying or threatens to delay the timely performance of this contract, that party shall, within twenty-four (24) hours, give notice thereof, including all relevant information with respect thereto, to the other party.

C.28 Ownership of Documents

All documents, data, products, graphics, computer programs and reports prepared by Contractor pursuant to the Contract shall be considered property of the County upon payment for services (and products, if applicable). All such items shall be delivered to County at the completion of work under the Contract, subject to the requirements of Section IV—Term of the Contract. Unless otherwise directed by County, Contractor may retain copies of such items.

C.29 Reserved.

C.30 Air, Water Pollution Control, Safety and Health

Contractor shall comply with all air pollution control, water pollution, safety and health ordinances and statutes, which apply to the work performed pursuant to this Contract.

C.31 Records

Contractor shall maintain all records and books pertaining to the delivery of services under this Contract and demonstrate accountability for contract performance. All records shall be complete and current and comply with all Contract requirements. Failure to maintain acceptable records shall be considered grounds for withholding of payments for invoices submitted and/or termination of the Contract.

All records relating to the Contractor's personnel, consultants, subcontractors, Services/Scope of Work and expenses pertaining to this Contract shall be kept in a generally acceptable accounting format. Records should include primary source documents. Fiscal records shall be kept in accordance with Generally Accepted Accounting Principles and must account for all funds, tangible assets, revenue and expenditures. Fiscal records must comply with the appropriate Office of Management and Budget (OMB) Circulars, which state the administrative requirements, cost principles and other standards for accountancy.

C.32 Relationship of the Parties

Nothing contained in this Contract shall be construed as creating a joint venture, partnership, or employment arrangement between the Parties hereto, nor shall either Party have the right, power or authority to create an obligation or duty, expressed or implied, on behalf of the other Party hereto.

C.33 Release of Information

No news releases, advertisements, public announcements or photographs arising out of the Contract or Contractor's relationship with County may be made or used without prior written approval of the County.

C.34 Representation of the County

In the performance of this Contract, Contractor, its agents and employees, shall act in an independent capacity and not as officers, employees, or agents of the San Bernardino County.

C.35 Strict Performance

Failure by a party to insist upon the strict performance of any of the provisions of this Contract by the other party, or the failure by a party to exercise its rights upon the default of the other party, shall not constitute a waiver of such party's right to insist and demand strict compliance by the other party with the terms of this Contract thereafter.

C.36 Subcontracting

Contractor shall obtain County's written consent, which County may withhold in its sole discretion, before entering into Contracts with or otherwise engaging any subcontractors who may supply any part of the Services to County. At County's request, Contractor shall provide information regarding the subcontractor's qualifications and a listing of a subcontractor's key personnel including, if requested by the County, resumes of proposed subcontractor personnel. Contractor shall remain directly responsible to County for its subcontractors and shall indemnify County for the actions or omissions of its subcontractors under the terms and conditions specified in Section G. All approved subcontractors shall be subject to the provisions of this Contract applicable to Contractor Personnel.

For any subcontractor, Contractor shall:

- 36.1** Be responsible for subcontractor compliance with the Contract and the subcontract terms and conditions; and
- 36.2** Ensure that the subcontractor follows County's reporting formats and procedures as specified by County.

- 36.3** Include in the subcontractor's subcontract substantially similar terms as are provided in Sections B. Contractor Responsibilities and C. General Contract Requirements.

Upon expiration or termination of this Contract for any reason, County will have the right to enter into direct Contracts with any of the Subcontractors. Contractor agrees that its arrangements with Subcontractors will not prohibit or restrict such Subcontractors from entering into direct Contracts with County.

C. 37 Subpoena

In the event that a subpoena or other legal process commenced by a third party in any way concerning the Goods or Services provided under this Contract is served upon Contractor or County, such party agrees to notify the other party in the most expeditious fashion possible following receipt of such subpoena or other legal process. Contractor and County further agree to cooperate with the other party in any lawful effort by such other party to contest the legal validity of such subpoena or other legal process commenced by a third party as may be reasonably required and at the expense of the party to whom the legal process is directed, except as otherwise provided herein in connection with defense obligations by Contractor for County.

C.38 Reserved.

C.39 Time of the Essence

Time is of the essence in performance of this Contract and of each of its provisions.

C.40 Reserved.

C.41 Conflict of Interest

Contractor shall make all reasonable efforts to ensure that no conflict of interest exists between its officers, employees, or subcontractors and the County. Contractor shall make a reasonable effort to prevent employees, Contractor, or members of governing bodies from using their positions for purposes that are, or give the appearance of being motivated by a desire for private gain for themselves or others such as those with whom they have family business, or other ties. Officers, employees, and agents of cities, counties, districts, and other local agencies are subject to applicable conflict of interest codes and state law. In the event the County determines a conflict of interest situation exists, any increase in costs, associated with the conflict of interest situation, may be disallowed by the County and such conflict may constitute grounds for termination of the Contract. This provision shall not be construed to prohibit employment of persons with whom Contractor's officers, employees, or agents have family, business, or other ties so long as the employment of such persons does not result in increased costs over those associated with the employment of any other equally qualified applicant.

C.42 Former County Administrative Officials

Contractor agrees to provide, or has already provided information on former San Bernardino County administrative officials (as defined below) who are employed by or represent Contractor. The information provided includes a list of former County administrative officials who terminated County employment within the last five years and who are now officers, principals, partners, associates or members of the business. The information also includes the employment with or representation of Contractor. For purposes of this provision, "County administrative official" is defined as a member of the Board of Supervisors or such officer's staff, County Executive Officer or member of such officer's staff, County department or group head, assistant department or group head, or any employee in the Exempt Group, Management Unit or Safety Management Unit.

C.43 Disclosure of Criminal and Civil Procedures

The County reserves the right to request the information described herein from the Contractor. Failure to provide the information may result in a termination of the Contract. The County also

reserves the right to obtain the requested information by way of a background check performed by an investigative firm. The Contractor also may be requested to provide information to clarify initial responses. Negative information discovered may result in Contract termination.

Contractor is required to disclose whether the firm, or any of its partners, principals, members, associates or key employees (as that term is defined herein), within the last ten years, has been indicted on or had charges brought against it or them (if still pending) or convicted of any crime or offense arising directly or indirectly from the conduct of the firm's business, or whether the firm, or any of its partners, principals, members, associates or key employees, has within the last ten years, been indicted on or had charges brought against it or them (if still pending) or convicted of any crime or offense involving financial misconduct or fraud. If the response is affirmative, the Contractor will be asked to describe any such indictments or charges (and the status thereof), convictions and the surrounding circumstances in detail.

In addition, the Contractor is required to disclose whether the firm, or any of its partners, principals, members, associates or key employees, within the last ten years, has been the subject of legal proceedings as defined herein arising directly from the provision of services by the firm or those individuals. "Legal proceedings" means any civil actions filed in a court of competent jurisdiction, or any matters filed by an administrative or regulatory body with jurisdiction over the firm or the individuals. If the response is affirmative, the Contractor will be asked to describe any such legal proceedings (and the status and disposition thereof) and the surrounding circumstances in detail.

For purposes of this provision "key employees" includes any individuals providing direct service to the County. "Key employees" do not include clerical personnel providing service at the firm's offices or locations.

C.44 Copyright

County shall have a royalty-free, non-exclusive and irrevocable license to publish, disclose, copy, translate, and otherwise use, copyright or patent, now and hereafter, all reports, studies, information, data, statistics, forms, designs, plans, procedures, systems, and any other materials or properties developed under this Contract including those covered by copyright, and reserves the right to authorize others to use or reproduce such material. All such materials developed under the terms of this Contract shall acknowledge the San Bernardino County as the funding agency and Contractor as the creator of the publication. No such materials, or properties produced in whole or in part under this Contract shall be subject to private use, copyright or patent right by Contractor in the United States or in any other country without the express written consent of County. Copies of all educational and training materials, curricula, audio/visual aids, printer material, and periodicals, assembled pursuant to this Contract must be filed with the County prior to publication.

C.45 Artwork, Proofs and Negatives

All artwork, proofs, and/or negatives in either print or digital format for anything produced under the terms of this Contract are the property of the County. These items must be returned to the County within ten (10) days, upon written notification to the Contractor. In the event of a failure to return the documents, the County is entitled to pursue any available legal remedies. In addition, the Contractor will be barred from all future solicitations, for a period of at least six (6) months.

C.46 Reserved

C.47 If Applicable Prevailing Wage Laws

By its execution of this Contract, Contractor certifies that it is aware of the requirements of California Labor Code Sections 1720 et seq. and 1770 et seq. as well as California Code of Regulations, Title 8, Section 16000 et seq. ("Prevailing Wage Laws"), which require the payment of prevailing wage rates and the performance of other requirements on certain "public works" and "maintenance" projects. Section 1720 of the California Labor Code states in part: "For purposes of this paragraph, 'construction' includes work performed during the design, site assessment,

feasibility study, and other preconstruction phases of construction including, but not limited to, inspection and land surveying work...” If the Services/Scope of Work are being performed as part of an applicable “public works” or “maintenance” project, as defined by the Prevailing Wage Laws, and if the total compensation is \$1,000 or more, Contractor agrees to fully comply with such Prevailing Wage Laws. Contractor shall make copies of the prevailing rates of per diem wages for each craft, classification or type of worker needed to execute the Services available to interested parties upon request and shall post copies at the Contractor's principal place of business and at the project site. Contractor will also adhere to any other applicable requirements, including but not limited to, those regarding the employment of apprentices, travel and subsistence pay, retention and inspection of payroll records, workers compensation and forfeiture of penalties prescribed in the Labor Code for violations. Contractor shall defend, indemnify and hold the County, its elected officials, officers, employees and agents free and harmless from any claims, liabilities, costs, penalties or interest arising out of any failure or alleged failure to comply with Prevailing Wage Laws. See Attachment A, which is attached and incorporated by reference, for additional information regarding Prevailing Wage Laws. Contractor shall comply with all applicable terms and conditions in Attachment A. The applicable general prevailing wage determinations are on file with the County and are available to any interested party on request. Contractor shall post a copy of the applicable prevailing wage determinations at the job site.

C.48 Reserved

C.49 Reserved

C.50 Reserved

C.51 Campaign Contribution Disclosure (SB 1439)

Contractor has disclosed to the County using Attachment B - Campaign Contribution Disclosure Senate Bill 1439, whether it has made any campaign contributions of more than \$250 to any member of the Board of Supervisors or other County elected officer [Sheriff, Assessor-Recorder-Clerk, Auditor-Controller/Treasurer/Tax Collector and the District Attorney] within the earlier of:

(1) the date of the submission of Contractor's proposal to the County, or (2) 12 months before the date this Contract was approved by the Board of Supervisors. Contractor acknowledges that under Government Code section 84308, Contractor is prohibited from making campaign contributions of more than \$250 to any member of the Board of Supervisors or other County elected officer for 12 months after the County's consideration of the Contract.

In the event of a proposed amendment to this Contract, the Contractor will provide the County a written statement disclosing any campaign contribution(s) of more than \$250 to any member of the Board of Supervisors or other County elected officer within the preceding 12 months of the date of the proposed amendment.

Campaign contributions include those made by any agent/person/entity on behalf of the Contractor or by a parent, subsidiary or otherwise related business entity of Contractor.

C.52 Reserved.

D. Delivery Date

The delivery date of the three Mobile Health Clinics (1 Mobile Health Clinic Dual Medical, 1 Mobile Health Clinic Hybrid Dental/Medical, 1 Mobile Health Clinic Dual Dental), with all specifications identified in Attachment C, shall be no later than 150 days from the date of deposit receipt.. Delivery shall be FOB Delivery to the County's place of delivery specified in Section B.2.

E. COUNTY RESPONSIBILITIES

E.1 County shall pay vendor in accordance with Section F. Fiscal Provisions: with Final Payment made after acceptance of three Mobile Health Clinics meeting all specifications identified in Attachment C to this contract. Delivery shall be FOB Delivery at County's place of delivery by the

delivery date identified in paragraph D. Vendor shall comply with invoicing requirements as stipulated by San Bernardino County.

F. FISCAL PROVISIONS

- F.1** The maximum amount of payment under this Contract shall not exceed \$1,299,000. The consideration to be paid to Contractor, as provided herein, shall be in full payment for all Contractor's services and expenses incurred in the performance hereof, including travel and per diem.
- F.2** Invoices shall be issued with a net sixty (60) day payment term with corresponding Purchase Order number stated on the invoice. Vendor shall comply with invoicing requirements as stipulated by San Bernardino County.
- F.3** Contractor shall accept all payments from County via electronic funds transfer (EFT) directly deposited into the Contractor's designated checking or other bank account. Contractor shall promptly comply with directions and accurately complete forms provided by County required to process EFT payments.
- F.4** County is exempt from Federal excise taxes and no payment shall be made for any personal property taxes levied on Contractor or on any taxes levied on employee wages. The County shall only pay for any State or local sales or use taxes on the services rendered or equipment and/or parts supplied to the County pursuant to the Contract.
- F.5** **Reserved.**
- F.6** **Reserved.**
- F.7** Contractor shall adhere to the County's Travel Management Policy (8-02 and 08-02SP1) when travel is pursuant to this Contract and for which reimbursement is sought from the County. In addition, Contractor is encouraged to utilize local transportation services, including but not limited to, the Ontario International Airport.
- F.8** The County will make a payment of 50% Down at Time of execution of Contract by both parties.
- F.9** The County will make a payment of 25% Due 45 Days after execution of Contract by both parties.
- F.10** The County will make a Final Payment of the remaining balance after inspection of the clinics upon delivery to San Bernardino County Department of Public Health.

G. INDEMNIFICATION AND INSURANCE REQUIREMENTS

G.1 Indemnification

- a. The CONTRACTOR agrees to indemnify, defend (with counsel reasonably approved by COUNTY) and hold harmless COUNTY and its authorized officers, employees, agents and volunteers from any and all claims, actions, losses, damages, and/or liability arising out of this contract from any cause whatsoever, including the acts, errors or omissions of any person and for any costs or expenses incurred by COUNTY on account of any claim except where such indemnification is prohibited by law. This indemnification provision shall apply regardless of the existence or degree of fault of indemnitees. The CONTRACTORS's indemnification obligation applies to COUNTY'S "active" as well as "passive" negligence but does not apply to COUNTY'S "sole negligence" or "willful misconduct" within the meaning of Civil Code Section 2782.
- b. COUNTY agrees to indemnify, defend (with counsel reasonably approved by CONTRACTOR) and hold harmless the CONTRACTOR and its authorized officers, employees, agents and volunteers from any and all claims, actions, losses, damages, and/or liability arising out of this

contract from any cause whatsoever, including the acts, errors or omissions of any person and for any costs or expenses incurred by the CONTRACTOR on account of any claim except where such indemnification is prohibited by law. This indemnification provision shall apply regardless of the existence or degree of fault of indemnitees. COUNTY'S indemnification obligation applies to the CONTRACTOR's "active" as well as "passive" negligence but does not apply to the CONTRACTOR's "sole negligence" or "willful misconduct" within the meaning of Civil Code Section 2782.

- c. In the event that COUNTY and/or CONTRACTOR are determined to be comparatively at fault for any claim, action, loss or damage which results from their respective obligations under this agreement, COUNTY and/or CONTRACTOR shall indemnify the other to the extent of its comparative fault.

G.2 Additional Insured

All policies, except for Worker's Compensation, Errors and Omissions and Professional Liability policies shall contain additional endorsements naming the County and its officers, employees, agents and volunteers as additional named insured with respect to liabilities arising out of the performance of services hereunder. The additional insured endorsements shall not limit the scope of coverage for the County to vicarious liability but shall allow coverage for the County to the full extent provided by the policy. Such additional insured coverage shall be at least as broad as Additional Insured (Form B) endorsement form ISO, CG 2010.11 85.

G.3 Waiver of Subrogation Rights

The Contractor shall require the carriers of required coverages to waive all rights of subrogation against the County, its officers, employees, agents, volunteers, contractors and subcontractors. All general or auto liability insurance coverage provided shall not prohibit the Contractor and Contractor's employees or agents from waiving the right of subrogation prior to a loss or claim. The Contractor hereby waives all rights of subrogation against the County.

G.4 Policies Primary and Non-Contributory

All policies required herein are to be primary and non-contributory with any insurance or self-insurance programs carried or administered by the County.

G.5 Severability of Interests

The Contractor agrees to ensure that coverage provided to meet these requirements is applicable separately to each insured and there will be no cross liability exclusions that preclude coverage for suits between the Contractor and the County or between the County and any other insured or additional insured under the policy.

G.6 Proof of Coverage

The Contractor shall furnish Certificates of Insurance to the County Department administering the Contract evidencing the insurance coverage at the time the Contract is executed, additional endorsements, as required shall be provided prior to the commencement of performance of services hereunder, which certificates shall provide that such insurance shall not be terminated or expire without thirty (30) days written notice to the Department, and Contractor shall maintain such insurance from the time Contractor commences performance of services hereunder until the completion of such services. Within fifteen (15) days of the commencement of this contract, the Contractor shall furnish a copy of the Declaration page for all applicable policies and will provide complete certified copies of the policies and endorsements immediately upon request.

G.7 Acceptability of Insurance Carrier

Unless otherwise approved by Risk Management, insurance shall be written by insurers authorized to do business in the State of California and with a minimum "Best" Insurance Guide rating of "A- VII".

G.8 Deductibles and Self-Insured Retention

Any and all deductibles or self-insured retentions in excess of \$10,000 shall be declared to and approved by Risk Management.

G.9 Failure to Procure Coverage

In the event that any policy of insurance required under this contract does not comply with the requirements, is not procured, or is canceled and not replaced, the County has the right but not the obligation or duty to cancel the contract or obtain insurance if it deems necessary and any premiums paid by the County will be promptly reimbursed by the Contractor or County payments to the Contractor will be reduced to pay for County purchased insurance.

G.10 Insurance Review

Insurance requirements are subject to periodic review by the County. The Director of Risk Management or designee is authorized, but not required, to reduce, waive or suspend any insurance requirements whenever Risk Management determines that any of the required insurance is not available, is unreasonably priced, or is not needed to protect the interests of the County. In addition, if the Department of Risk Management determines that heretofore unreasonably priced or unavailable types of insurance coverage or coverage limits become reasonably priced or available, the Director of Risk Management or designee is authorized, but not required, to change the above insurance requirements to require additional types of insurance coverage or higher coverage limits, provided that any such change is reasonable in light of past claims against the County, inflation, or any other item reasonably related to the County's risk.

Any change requiring additional types of insurance coverage or higher coverage limits must be made by amendment to this contract. Contractor agrees to execute any such amendment within thirty (30) days of receipt.

Any failure, actual or alleged, on the part of the County to monitor or enforce compliance with any of the insurance and indemnification requirements will not be deemed as a waiver of any rights on the part of the County.

- G.11** The Contractor agrees to provide insurance set forth in accordance with the requirements herein. If the Contractor uses existing coverage to comply with these requirements and that coverage does not meet the specified requirements, the Contractor agrees to amend, supplement or endorse the existing coverage to do so.

Without in anyway affecting the indemnity herein provided and in addition thereto, the Contractor shall secure and maintain throughout the contract term the following types of insurance with limits as shown:

- G.11.1** Workers' Compensation/Employer's Liability – A program of Workers' Compensation insurance or a state-approved, self-insurance program in an amount and form to meet all applicable requirements of the Labor Code of the State of California, including Employer's Liability with \$250,000 limits covering all persons including volunteers providing services on behalf of the Contractor and all risks to such persons under this contract.

If Contractor has no employees, it may certify or warrant to the County that it does not currently have any employees or individuals who are defined as "employees" under the Labor Code and the requirement for Workers' Compensation coverage will be waived by the County's Director of Risk Management.

With respect to Contractors that are non-profit corporations organized under California or Federal law, volunteers for such entities are required to be covered by Workers' Compensation insurance.

- G.11.2** Commercial/General Liability Insurance – The Contractor shall carry General Liability Insurance covering all operations performed by or on behalf of the Contractor providing coverage for bodily injury and property damage with a combined single limit of not less than one million dollars (\$1,000,000), per occurrence. The policy coverage shall include:
- a. Premises operations and mobile equipment.
 - b. Products and completed operations.
 - c. Broad form property damage (including completed operations).
 - d. Explosion, collapse and underground hazards.
 - e. Personal injury.
 - f. Contractual liability.
 - g. \$2,000,000 general aggregate limit.

- G.11.3** Automobile Liability Insurance – Primary insurance coverage shall be written on ISO Business Auto coverage form for all owned, hired and non-owned automobiles or symbol 1 (any auto). The policy shall have a combined single limit of not less than one million dollars (\$1,000,000) for bodily injury and property damage, per occurrence.

If the Contractor is transporting one or more non-employee passengers in performance of contract services, the automobile liability policy shall have a combined single limit of two million dollars (\$2,000,000) for bodily injury and property damage per occurrence.

If the Contractor owns no autos, a non-owned auto endorsement to the General Liability policy described above is acceptable.

- G.11.4** Umbrella Liability Insurance – An umbrella (over primary) or excess policy may be used to comply with limits or other primary coverage requirements. When used, the umbrella policy shall apply to bodily injury/property damage, personal injury/advertising injury and shall include a “dropdown” provision providing primary coverage for any liability not covered by the primary policy. The coverage shall also apply to automobile liability.

G.11.5 **Reserved.**

G.11.6 **Reserved.**

G.11.7 **Reserved.**

H. RIGHT TO MONITOR AND AUDIT

H.1 The County, State and Federal government shall have absolute right to review and audit all records, books, papers, documents, corporate minutes, and other pertinent items as requested, and shall have absolute right to monitor the performance of Contractor in the delivery of services provided under this Contract. Contractor shall give full cooperation, in any auditing or monitoring conducted. Contractor shall cooperate with the County in the implementation, monitoring, and evaluation of this Contract and comply with any and all reporting requirements established by the County.

H.2 All records pertaining to services delivered and all fiscal, statistical and management books and records shall be available for examination and audit by County representatives for a period of three years after final payment under this Contract or until all pending County, State and Federal audits are completed, whichever is later.

I. CORRECTION OF PERFORMANCE DEFICIENCIES

I.1 Failure by Contractor to comply with any of the provisions, covenants, requirements or conditions of this Contract shall be a material breach of this Contract.

- I.2** In the event of a non-cured breach, County may, at its sole discretion and in addition to any other remedies available at law, in equity, or otherwise specified in this Contract:
- a. Afford Contractor thereafter a time period within which to cure the breach, which period shall be established at the sole discretion of County; and/or
 - b. Discontinue reimbursement to Contractor for and during the period in which Contractor is in breach, which reimbursement shall not be entitled to later recovery; and/or
 - c. Withhold funds pending duration of the breach; and/or
 - d. Offset against any monies billed by Contractor but yet unpaid by County those monies disallowed pursuant to Item "b" of this paragraph; and/or
 - e. Terminate this Contract immediately and be relieved of the payment of any consideration to Contractor. In the event of such termination, the County may proceed with the work in any manner deemed proper by the County. The cost to the County shall be deducted from any sum due to the Contractor under this Contract and the balance, if any, shall be paid by the Contractor upon demand.

J. NOTICES

All written notices provided for in this Contract or which either party desires to give to the other shall be deemed fully given, when made in writing and either served personally, or by facsimile, or deposited in the United States mail, postage prepaid, and addressed to the other party as follows:

San Bernardino County
Department of Public Health
Attn: Janki Patel, Assistant Director
451 E. Vanderbilt Way, 4th Floor
San Bernardino, CA 92408-0012

M3 Group Inc.
(DBA Mission Mobile Medical Group)
Attn: Monica Grashuis
7700 Boeing Drive
Greensboro, NC 27409

Notice shall be deemed communicated two (2) County working days from the time of mailing if mailed as provided in this paragraph.

K. ENTIRE AGREEMENT

This Contract, including all Exhibits and other attachments, which are attached hereto and incorporated by reference, and other documents incorporated herein, represents the final, complete and exclusive agreement between the parties hereto. Any prior agreement, promises, negotiations or representations relating to the subject matter of this Contract not expressly set forth herein are of no force or effect. This Contract is executed without reliance upon any promise, warranty or representation by any party or any representative of any party other than those expressly contained herein. Each party has carefully read this Contract and signs the same of its own free will.

L. ELECTRONIC SIGNATURES

This Agreement may be executed in any number of counterparts, each of which so executed shall be deemed to be an original, and such counterparts shall together constitute one and the same Agreement. The parties shall be entitled to sign and transmit an electronic signature of this Agreement (whether by facsimile, PDF or other mail transmission), which signature shall be binding on the party whose name is contained therein. Each party providing an electronic signature agrees to promptly execute and deliver to the other party an original signed Agreement upon request.

IN WITNESS WHEREOF, the San Bernardino County and the Contractor have each caused this Contract to be subscribed by its respective duly authorized officers, on its behalf.

SAN BERNARDINO COUNTY

► *Dawn Rowe*

Dawn Rowe, Chair, Board of Supervisors

Dated: JUN 25 2024

SIGNED AND CERTIFIED THAT A COPY OF THIS DOCUMENT HAS BEEN DELIVERED TO THE CHAIRMAN OF THE BOARD

By *[Signature]*
Lynna Monell
Clerk of the Board of Supervisors
of the San Bernardino County
Deputy



M3 Group Inc. (DBA Mission Mobile Medical Group)

(Print or type name of corporation, company, contractor, etc.)

By *[Signature]*
Brad Watson (Jun 13, 2024 17:52 EDT)

(Authorized signature - sign in blue ink)

Name Brad Watson

(Print or type name of person signing contract)

Title Chief Revenue Officer



(Print or Type)

Dated: 06/13/2024

Address 7700 Boeing Drive

Greensboro, NC 27409

FOR COUNTY USE ONLY

Approved as to Legal Form	Reviewed for Contract Compliance	Reviewed/Approved by Department
 Adam Ebright, Deputy County Counsel	►	 Joshua Dugas, Director
Date <u>06/13/2024</u>	Date _____	Date <u>06/13/2024</u>

ATTACHMENT A

PREVAILING WAGE REQUIREMENTS

A. All or a portion of the Scope of Work in the Contract requires the payment of prevailing wages and compliance with the following requirements:

1. Determination of Prevailing Rates:

Pursuant to Labor Code sections 1770, et seq., the County has obtained from the Director of the Department of Industrial Relations (DIR) pursuant to the California Labor Code, the general prevailing rates of per diem wages and the prevailing rates for holiday and overtime work in the locality in which the Scope of Work is to be performed. Copies of said rates are on file with the County, will be made available for inspection during regular business hours, may be included elsewhere in the specifications for the Scope of Work, and are also available online at www.dir.ca.gov. The wage rate for any classification not listed, but which may be required to execute the Scope of Work, shall be commensurate and in accord with specified rates for similar or comparable classifications for those performing similar or comparable duties. In accordance with Labor Code section 1773.2, the Contractor shall post, at appropriate and conspicuous locations on the job site, a schedule showing all applicable prevailing wage rates and shall comply with the requirements of Labor Code sections 1773, et seq.

2. Payment of Prevailing Rates

Each worker of the Contractor, or any subcontractor, engaged in the Scope of Work, shall be paid not less than the general prevailing wage rate, regardless of any contractual relationship which may be alleged to exist between the Contractor or any subcontractor, and such worker.

3. Prevailing Rate Penalty

The Contractor shall, as a penalty, forfeit two hundred dollars (\$200.00) to the County for each calendar day or portion thereof, for each worker paid less than the prevailing rates as determined by the Director of the DIR for such work or craft in which such worker is employed by the Contractor or by any subcontractor in connection with the Scope of Work. Pursuant to California Labor Code section 1775, the difference between such prevailing wage rates and the amount paid to each worker for each calendar day, or portion thereof, for which each worker was paid less than the prevailing wage rate, shall be paid to each worker by the Contractor.

4. Ineligible Contractors:

Pursuant to the provisions of Labor Code section 1777.1, the Labor Commissioner publishes and distributes a list of contractors ineligible to perform work as a contractor or subcontractor on a public works project. This list of debarred contractors is available from the DIR website at <http://www.dir.ca.gov/Public-Works/PublicWorks.html>. Any contract entered into between a contractor and a debarred subcontractor is void as a matter of law. A debarred subcontractor may not receive any public money for performing work as a subcontractor on a public works contract, and any public money that may have been paid to a debarred subcontractor by a contractor on the project shall be returned to the County. The Contractor shall be responsible for the payment of wages to workers as a debarred subcontractor who has been allowed to work on the Scope of Work.

5. Payroll Records:

a. Pursuant to California Labor Code section 1776, the Contractor and each subcontractor, shall keep accurate certified payroll records, showing the name, address, social security number, work classification, straight time and overtime hours worked each day and week, and the actual per diem wages paid to each journeyman, apprentice, worker or other employee employed by them in connection with the Scope of Work. The payroll records enumerated herein shall be verified by a written declaration made under penalty of perjury that the information contained in the payroll record is true and correct and that the Contractor or subcontractor has complied with the requirements of the California Labor Code sections 1771, 1811, and 1815 for any Scope of Work performed by his or her employees. The payroll records shall be available for inspection at all reasonable hours at the principal office of the Contractor on the following basis:

- i. A certified copy of an employee's payroll record shall be made available for inspection or furnished to such employee or his/her authorized representative on request;
- ii. A certified copy of all payroll records shall be made available for inspection or furnished upon request to the County, the Division of Labor Standards Enforcement of the DIR;
- iii. A certified copy of payroll records shall be made available upon request to the public for inspection or copies thereof made; provided, however, that a request by the public shall be made through either the County or the Division of Labor Standards Enforcement. If the requested payroll records have not been previously provided to the County or the Division of Labor Standards Enforcement, the requesting party shall, prior to being provided the records, reimburse the cost of preparation by the Contractor, subcontractor and the entity through which the request was made; the public shall not be given access to such records at the principal office of the Contractor;

- iv. The Contractor shall file a certified copy of the payroll records with the entity that requested such records within ten (10) days after receipt of a written request; and
 - v. Copies provided to the public, by the County or the Division of Labor Standards Enforcement shall be marked or obliterated in such a manner as to prevent disclosure of an individual's name, address and social security number. The name and address of the Contractor or any subcontractor, performing a part of the Scope of Work shall not be marked or obliterated. The Contractor shall inform the County of the location of payroll records, including the street address, city and county and shall, within five (5) working days, provide a notice of a change of location and address.
- b. The Contractor shall have ten (10) days from receipt of the written notice specifying in what respects the Contractor must comply with the above requirements. In the event Contractor does not comply with the requirements of this section within the ten (10) day period, the Contractor shall, as a penalty to the County, forfeit one-hundred dollars (\$100.00) for each calendar day, or portion thereof, for each worker, until strict compliance is effectuated. Upon the request of the Division of Labor Standards Enforcement, such penalty shall be withheld from any portion of the payments then due or to become due to the Contractor.

6. Limits on Hours of Work:

Pursuant to California Labor Code section 1810, eight (8) hours of labor shall constitute a legal day's work. Pursuant to California Labor Code section 1811, the time of service of any worker employed at any time by the Contractor or by a subcontractor, upon the Scope of Work or upon any part of the Scope of Work, is limited and restricted to eight (8) hours during any one calendar day and forty (40) hours during any one calendar week, except as provided for under Labor Code section 1815. Notwithstanding the foregoing provisions, work performed by employees of Contractor or any subcontractor, in excess of eight (8) hours per day and forty (40) hours during any one week, shall be permitted upon compensation for all hours worked in excess of eight (8) hours per day at not less than one and one-half (1½) times the basic rate of pay.

7. Penalty for Excess Hours:

The Contractor shall pay to the County a penalty of twenty-five dollars (\$25.00) for each worker employed on the Scope of Work by the Contractor or any subcontractor, for each calendar day during which such worker is required or permitted to work more than eight (8) hours in any calendar day and forty (40) hours in any one calendar week, in violation of the provisions of the California Labor Code, unless compensation to the worker so employed by the Contractor is not less than one and one-half (1½) times the basic rate of pay for all hours worked in excess of eight (8) hours per day.

8. Senate Bill 854 (Chapter 28, Statutes of 2014) and Senate Bill 96 (Chapter 28, Statutes of 2017) Requirements:

- a. Contractor shall comply with Senate Bill 854 and Senate Bill 96. The requirements include, but are not limited to, the following:
 - i. No contractor or subcontractor may be listed on a bid proposal for a public works project unless registered with the DIR pursuant to Labor Code section 1725.5, with limited exceptions from this requirements for bid purposes only as allowed under Labor Code section 1771.1(a).
 - ii. No contractor or subcontractor may be awarded a contract for public work or perform work on a public works project unless registered with the DIR pursuant to Labor Code section 1725.5.
 - iii. This project is subject to compliance monitoring and enforcement by the DIR.
 - iv. As required by the DIR, Contractor is required to post job site notices, as prescribed by regulation, regarding compliance monitoring and enforcement by the DIR.
 - v. Contractors and all subcontractors must submit certified payroll records online to the Labor Commissioner for all public works projects.
 - 1) The certified payroll must be submitted at least monthly to the Labor Commissioner.
 - 2) The County reserves the right to require Contractor and all subcontractors to submit certified payroll records more frequently than monthly to the Labor Commissioner.
 - 3) The certified payroll records must be in a format prescribed by the Labor Commissioner.
 - vi. Registration with the DIR and the submission of certified payroll records to the Labor Commissioner are not required if the public works project is \$25,000 or less when the project is for construction, alteration, demolition, installation or repair work, or if the public works project is \$15,000 or less when the project is for maintenance work.

- b. Labor Code section 1725.5 states the following:

"A contractor shall be registered pursuant to this section to be qualified to bid on, be listed in a bid proposal, subject to the requirements of Section 4104 of the Public Contract Code, or engage in the performance of any public work contract that is subject to the requirements of this chapter. For the purposes of this section, "contractor" includes a subcontractor as defined by Section 1722.1.

(a) To qualify for registration under this section, a contractor shall do all of the following:

(1) (A) Register with the Department of Industrial Relations in the manner prescribed by the department and pay an initial nonrefundable application fee of four hundred dollars (\$400) to qualify for registration under this section and an annual renewal fee on or before July 1 of each year thereafter. The annual renewal fee shall be in a uniform amount set by the Director of Industrial Relations, and the initial registration and renewal fees may be adjusted no more than annually by the director to support the costs specified in Section 1771.3.

(B) Beginning June 1, 2019, a contractor may register or renew according to this subdivision in annual increments up to three years from the date of registration. Contractors who wish to do so will be required to prepay the applicable nonrefundable application or renewal fees to qualify for the number of years for which they wish to preregister.

(2) Provide evidence, disclosures, or releases as are necessary to establish all of the following:

(A) Workers' compensation coverage that meets the requirements of Division 4 (commencing with Section 3200) and includes sufficient coverage for any worker whom the contractor employs to perform work that is subject to prevailing wage requirements other than a contractor who is separately registered under this section. Coverage may be evidenced by a current and valid certificate of workers' compensation insurance or certification of self-insurance required under Section 7125 of the Business and Professions Code.

(B) If applicable, the contractor is licensed in accordance with Chapter 9 (commencing with Section 7000) of the Business and Professions Code.

(C) The contractor does not have any delinquent liability to an employee or the state for any assessment of back wages or related damages, interest, fines, or penalties pursuant to any final judgment, order, or determination by a court or any federal, state, or local administrative agency, including a confirmed arbitration award. However, for purposes of this paragraph, the contractor shall not be disqualified for any judgment, order, or determination that is under appeal, provided that the contractor has secured the payment of any amount eventually found due through a bond or other appropriate means.

(D) The contractor is not currently debarred under Section 1777.1 or under any other federal or state law providing for the debarment of contractors from public works.

(E) The contractor has not bid on a public works contract, been listed in a bid proposal, or engaged in the performance of a contract for public works without being lawfully registered in accordance with this section, within the preceding 12 months or since the effective date of the requirements set forth in subdivision (e),

whichever is earlier. If a contractor is found to be in violation of the requirements of this paragraph, the period of disqualification shall be waived if both of the following are true:

(i) The contractor has not previously been found to be in violation of the requirements of this paragraph within the preceding 12 months.

(ii) The contractor pays an additional nonrefundable penalty registration fee of two thousand dollars (\$2,000).

(b) Fees received pursuant to this section shall be deposited in the State Public Works Enforcement Fund established by Section 1771.3 and shall be used only for the purposes specified in that section.

(c) A contractor who fails to pay the renewal fee required under paragraph (1) of subdivision (a) on or before the expiration of any prior period of registration shall be prohibited from bidding on or engaging in the performance of any contract for public work until once again registered pursuant to this section. If the failure to pay the renewal fee was inadvertent, the contractor may renew its registration retroactively by paying an additional nonrefundable penalty renewal fee equal to the amount of the renewal fee within 90 days of the due date of the renewal fee.

(d) If, after a body awarding a contract accepts the contractor's bid or awards the contract, the work covered by the bid or contract is determined to be a public work to which Section 1771 applies, either as the result of a determination by the director pursuant to Section 1773.5 or a court decision, the requirements of this section shall not apply, subject to the following requirements:

(1) The body that awarded the contract failed, in the bid specification or in the contract documents, to identify as a public work that portion of the work that the determination or decision subsequently classifies as a public work.

(2) Within 20 days following service of notice on the awarding body of a determination by the Director of Industrial Relations pursuant to Section 1773.5 or a decision by a court that the contract was for public work as defined in this chapter, the contractor and any subcontractors are registered under this section or are replaced by a contractor or subcontractors who are registered under this section.

(3) The requirements of this section shall apply prospectively only to any subsequent bid, bid proposal, contract, or work performed after the awarding body is served with notice of the determination or decision referred to in paragraph (2).

(e) The requirements of this section shall apply to any bid proposal submitted on or after March 1, 2015, to any contract for public work, as defined in this chapter, executed on or after April 1, 2015, and to any work performed under a contract for public work on or after January 1, 2018, regardless of when the contract for public work was executed.

(f) This section does not apply to work performed on a public works project of twenty-five thousand dollars (\$25,000) or less when the project is for construction, alteration, demolition, installation, or repair work or to work performed on a public works project of fifteen thousand dollars (\$15,000) or less when the project is for maintenance work.”

c. Labor Code section 1771.1 states the following:

“(a) A contractor or subcontractor shall not be qualified to bid on, be listed in a bid proposal, subject to the requirements of Section 4104 of the Public Contract Code, or engage in the performance of any contract for public work, as defined in this chapter, unless currently registered and qualified to perform public work pursuant to Section 1725.5. It is not a violation of this section for an unregistered contractor to submit a bid that is authorized by Section 7029.1 of the Business and Professions Code or by Section 10164 or 20103.5 of the Public Contract Code, provided the contractor is registered to perform public work pursuant to Section 1725.5 at the time the contract is awarded.

(b) Notice of the requirement described in subdivision (a) shall be included in all bid invitations and public works contracts, and a bid shall not be accepted nor any contract or subcontract entered into without proof of the contractor or subcontractor's current registration to perform public work pursuant to Section 1725.5.

(c) An inadvertent error in listing a subcontractor who is not registered pursuant to Section 1725.5 in a bid proposal shall not be grounds for filing a bid protest or grounds for considering the bid nonresponsive, provided that any of the following apply:

(1) The subcontractor is registered prior to the bid opening.

(2) Within 24 hours after the bid opening, the subcontractor is registered and has paid the penalty registration fee specified in subparagraph (E) of paragraph (2) of subdivision (a) of Section 1725.5.

(3) The subcontractor is replaced by another registered subcontractor pursuant to Section 4107 of the Public Contract Code.

(d) Failure by a subcontractor to be registered to perform public work as required by subdivision (a) shall be grounds under Section 4107 of the Public Contract Code for the contractor, with the consent of the awarding authority, to substitute a subcontractor who is registered to perform public work pursuant to Section 1725.5 in place of the unregistered subcontractor.

(e) The department shall maintain on its Internet Web site a list of contractors who are currently registered to perform public work pursuant to Section 1725.5.

(f) A contract entered into with any contractor or subcontractor in violation of subdivision (a) shall be subject to cancellation, provided that a contract for public work shall not be unlawful, void, or voidable solely due to the failure of the awarding body, contractor, or any subcontractor to comply with the requirements of Section 1725.5 or this section.

(g) If the Labor Commissioner or his or her designee determines that a contractor or subcontractor engaged in the performance of any public work contract without having been registered in accordance with this section, the contractor or subcontractor shall forfeit, as a civil penalty to the state, one hundred dollars (\$100) for each day of work performed in violation of the registration requirement, not to exceed an aggregate penalty of eight thousand dollars (\$8,000) in addition to any penalty registration fee assessed pursuant to clause (ii) of subparagraph (E) of paragraph (2) of subdivision (a) of Section 1725.5.

(h)(1) In addition to, or in lieu of, any other penalty or sanction authorized pursuant to this chapter, a higher tiered public works contractor or subcontractor who is found to have entered into a subcontract with an unregistered lower tier subcontractor to perform any public work in violation of the requirements of Section 1725.5 or this section shall be subject to forfeiture, as a civil penalty to the state, of one hundred dollars (\$100) for each day the unregistered lower tier subcontractor performs work in violation of the registration requirement, not to exceed an aggregate penalty of ten thousand dollars (\$10,000).

(2) The Labor Commissioner shall use the same standards specified in subparagraph (A) of paragraph (2) of subdivision (a) of Section 1775 when determining the severity of the violation and what penalty to assess, and may waive the penalty for a first time violation that was unintentional and did not hinder the Labor Commissioner's ability to monitor and enforce compliance with the requirements of this chapter.

(3) A higher tiered public works contractor or subcontractor shall not be liable for penalties assessed pursuant to paragraph (1) if the lower tier subcontractor's performance is in violation of the requirements of Section 1725.5 due to the revocation of a previously approved registration.

(4) A subcontractor shall not be liable for any penalties assessed against a higher tiered public works contractor or subcontractor pursuant to paragraph (1). A higher tiered public works contractor or subcontractor may not require a lower tiered subcontractor to indemnify or otherwise be liable for any penalties pursuant to paragraph (1).

(i) The Labor Commissioner or his or her designee shall issue a civil wage and penalty assessment, in accordance with the provisions of Section 1741, upon determination of penalties pursuant to subdivision (g) and subparagraph (B) of paragraph (1) of subdivision (h). Review of a civil wage and penalty assessment issued under this subdivision may be requested in accordance with the provisions of Section 1742. The regulations of the Director of Industrial Relations, which govern proceedings for review of civil wage and penalty assessments and the withholding of contract payments under Article 1 (commencing with Section 1720) and Article 2 (commencing with Section 1770), shall apply.

(j)(1) Where a contractor or subcontractor engages in the performance of any public work contract without having been registered in violation of the requirements of Section 1725.5 or this section, the Labor Commissioner shall issue and serve a stop order prohibiting the use of the unregistered contractor or the unregistered subcontractor on all public works until the unregistered contractor or unregistered subcontractor is registered. The stop order shall not apply to work by registered contractors or subcontractors on the public work.

(2) A stop order may be personally served upon the contractor or subcontractor by either of the following methods:

(A) Manual delivery of the order to the contractor or subcontractor personally.

(B) Leaving signed copies of the order with the person who is apparently in charge at the site of the public work and by thereafter mailing copies of the order by first class mail, postage prepaid to the contractor or subcontractor at one of the following:

(i) The address of the contractor or subcontractor on file with either the Secretary of State or the Contractors' State License Board.

(ii) If the contractor or subcontractor has no address on file with the Secretary of State or the Contractors' State License Board, the address of the site of the public work.

(3) The stop order shall be effective immediately upon service and shall be subject to appeal by the party contracting with the unregistered contractor or subcontractor, by the unregistered contractor or subcontractor, or both. The appeal, hearing, and any further review of the hearing decision shall be governed by the procedures, time limits, and other requirements specified in subdivision (a) of Section 238.1.

(4) Any employee of an unregistered contractor or subcontractor who is affected by a work stoppage ordered by the commissioner pursuant to this subdivision shall be paid at his or her regular hourly prevailing wage rate by that employer for any hours the employee would have worked but for the work stoppage, not to exceed 10 days.

(k) Failure of a contractor or subcontractor, owner, director, officer, or managing agent of the contractor or subcontractor to observe a stop order issued and served upon him or her pursuant to subdivision (j) is guilty of a misdemeanor punishable by imprisonment in county jail not exceeding 60 days or by a fine not exceeding ten thousand dollars (\$10,000), or both.

(l) This section shall apply to any bid proposal submitted on or after March 1, 2015, and any contract for public work entered into on or after April 1, 2015. This section shall also apply to the performance of any public work, as defined in this chapter, on or after January 1, 2018, regardless of when the contract for public work was entered.

(m) Penalties received pursuant to this section shall be deposited in the State Public Works Enforcement Fund established by Section 1771.3 and shall be used only for the purposes specified in that section.

(n) This section shall not apply to work performed on a public works project of twenty-five thousand dollars (\$25,000) or less when the project is for construction, alteration, demolition, installation, or repair work or to work performed on a public works project of fifteen thousand dollars (\$15,000) or less when the project is for maintenance work."

d. Labor Code section 1771.4 states the following:

"a) All of the following are applicable to all public works projects that are otherwise subject to the requirements of this chapter:

(1) The call for bids and contract documents shall specify that the project is subject to compliance monitoring and enforcement by the Department of Industrial Relations.

(2) The awarding body shall post or require the prime contractor to post job site notices, as prescribed by regulation.

(3) Each contractor and subcontractor shall furnish the records specified in Section 1776 directly to the Labor Commissioner, in the following manner:

- (A) At least monthly or more frequently if specified in the contract with the awarding body.
- (B) In a format prescribed by the Labor Commissioner.
- (4) If the contractor or subcontractor is not registered pursuant to Section 1725.5 and is performing work on a project for which registration is not required because of subdivision (f) of Section 1725.5, the unregistered contractor or subcontractor is not required to furnish the records specified in Section 1776 directly to the Labor Commissioner but shall retain the records specified in Section 1776 for at least three years after completion of the work.
- (5) The department shall undertake those activities it deems necessary to monitor and enforce compliance with prevailing wage requirements.
- (b) The Labor Commissioner may exempt a public works project from compliance with all or part of the requirements of subdivision (a) if either of the following occurs:
 - (1) The awarding body has enforced an approved labor compliance program, as defined in Section 1771.5, on all public works projects under its authority, except those deemed exempt pursuant to subdivision (a) of Section 1771.5, continuously since December 31, 2011.
 - (2) The awarding body has entered into a collective bargaining agreement that binds all contractors performing work on the project and that includes a mechanism for resolving disputes about the payment of wages.
- (c) The requirements of paragraph (1) of subdivision (a) shall only apply to contracts for public works projects awarded on or after January 1, 2015.
- (d) The requirements of paragraph (3) of subdivision (a) shall apply to all contracts for public work, whether new or ongoing, on or after January 1, 2016.”

B. STATE PUBLIC WORKS APPRENTICESHIP REQUIREMENTS

1. State Public Works Apprenticeship Requirements:

- a. The Contractor is responsible for compliance with Labor Code section 1777.5 and the California Code of Regulations, title 8, sections 230 – 230.2 for all apprenticeable occupations (denoted with “#” symbol next to craft name in DIR Prevailing Wage Determination), whether employed by the Contractor, subcontractor, vendor or consultant. Included in these requirements is (1) the Contractor’s requirement to provide notification (i.e. DAS-140) to the appropriate apprenticeship committees; (2) pay training fund contributions for each apprenticeable hour employed on the Contract; and (3) utilize apprentices in a minimum ratio of not less than one apprentice hour for each five journeyman hours by completion of Contract work (unless an exception is granted in accordance with Labor Code section 1777.5) or request for the dispatch of apprentices.
- b. Any apprentices employed to perform any of the Scope of Work shall be paid the standard wage to apprentices under the regulations of the craft or trade for which such apprentice is employed, and such individual shall be employed only for the work of the craft or trade to which such individual is registered. Only apprentices, as defined in California Labor Code section 3077, who are in training under apprenticeship standards and written apprenticeship agreements under California Labor Code sections 3070 et seq. are eligible to be employed for the Scope of Work. The employment and training of each apprentice shall be in accordance with the provisions of the apprenticeship standards and apprentice agreements under which such apprentice is training.

2. Compliance with California Labor Code section 1777.5 requires all public works contractors to:

- a. Submit Contract Award Information (DAS-140):
 - i. Although there are a few exemptions (identified below), all Contractors, regardless of union affiliation, must submit contract award information when performing on a California public works project.
 - ii. The DAS-140 is a notification “announcement” of the Contractor’s participation on a public works project—*it is not a request for the dispatch of an apprentice.*
 - iii. Contractors shall submit the contract award information (you may use form DAS 140) within 10 days of the execution of the prime contract or subcontract, but in no event later than the first day in which the Contractor has workers employed on the public work.
 - iv. Contractors who are already approved to train apprentices (i.e. check “Box 1” on the DAS-140) shall only be required to submit the form to their approved program.
 - v. Contractors who are NOT approved to train apprentices (i.e. those that check either “Box 2” or “Box 3” on the DAS-140) shall submit the DAS-140 TO EACH of the apprenticeship program sponsors in the area of your public works project. For a listing of apprenticeship programs see

<http://www.dir.ca.gov/Databases/das/pwaddrstart.asp>.

- b. Employ Registered Apprentices
 - i. Labor Code section 1777.5 requires that a contractor performing work in an "apprenticeable" craft must employ one (1) hour of apprentice work for every five (5) hours performed by a journeyman. This ratio shall be met prior to the Contractor's completion of work on the project. "Apprenticeable" crafts are denoted with a pound symbol "#" in front of the craft name on the prevailing wage determination.
 - ii. All Contractors who do not fall within an exemption category (see below) must request for dispatch of an apprentice from an apprenticeship program (for each apprenticeable craft or trade) by giving the program actual notice of at least 72 hours (business days only) before the date on which apprentices are required.
 - iii. Contractors may use the "DAS-142" form for making a request for the dispatch of an apprentice.
 - iv. Contractors who are participating in an approved apprenticeship training program and who did not receive sufficient number of apprentices from their initial request must request dispatch of apprentices from ALL OTHER apprenticeship committees in the project area in order to fulfill this requirement.
 - v. Contractor should maintain and submit proof (when requested) of its DAS-142 submittal to the apprenticeship committees (e.g. fax transmittal confirmation). A Contractor has met its requirement to employ apprentices only after it has successfully made a dispatch request to all apprenticeship programs in the project area.
 - vi. Only "registered" apprentices may be paid the prevailing apprentice rates and must, at all times work under the supervision of a Journeyman (Cal. Code Regs., tit 8, § 230.1).
- c. Make Training Fund Contributions
 - i. Contractors performing in apprenticeable crafts on public works projects, must make training fund contributions in the amount established in the prevailing wage rate publication for journeymen and apprentices.
 - ii. Contractors may use the "CAC-2" form for submittal of their training fund contributions.
 - iii. Contractors who do not submit their training fund contributions to an approved apprenticeship training program must submit their contributions to the California Apprenticeship Council (CAC), PO Box 420603, San Francisco, CA 94142-0603.
 - iv. Training fund contributions to the CAC are due and payable on the 15th day of the month for work performed during the preceding month.
 - v. The "training" contribution amount identified on the prevailing wage determination shall not be paid to the worker, unless the worker falls within one of the exemption categories listed below.

3. Exemptions to Apprenticeship Requirements:

- a. The following are exempt from having to comply with California apprenticeship requirements. These types of contractors do not need to submit a DAS-140, DAS-142, make training fund contributions, or utilize apprentices:
 - i. When the Contractor holds a sole proprietor license ("Owner-Operator") and no workers were employed by the Contractor. In other words, the contractor performed the entire work from start to finish and worked alone.
 - ii. Contractors performing in non-apprenticeable crafts. "Apprenticeable" crafts are denoted with a pound symbol "#" in front of the craft name on the prevailing wage determination.
 - iii. When the Contractor has a direct contract with the Public Agency that is under \$30,000.
 - iv. When the project is 100% federally-funded and the funding of the project does not contain any city, county, and/or state monies (unless the project is administered by a state agency in which case the apprenticeship requirements apply).
 - v. When the project is a private project not covered by the definition of public works as found in Labor Code section 1720.

4. Exemption from Apprenticeship Ratios:

- a. The Joint Apprenticeship Committee shall have the discretion to grant a certificate, which shall be subject to the approval of the Administrator of Apprenticeship, exempting the Contractor from the 1-to-5 ratio set forth in this Section when it finds that any one of the following conditions are met:
 - i. Unemployment for the previous three-month period in such area exceeds an average of fifteen percent (15%); or
 - ii. The number of apprentices in training in such area exceeds a ratio of 1-to-5 in relation to journeymen; or

- iii. The Apprenticeable Craft or Trade is replacing at least one-thirtieth (1/30) of its journeymen annually through apprenticeship training, either on a statewide basis or on a local basis; or
 - iv. If assignment of an apprentice to any work performed under the Contract Documents would create a condition which would jeopardize such apprentice's life or the life, safety or property of fellow employees or the public at large, or if the specific task to which the apprentice is to be assigned is of such a nature that training cannot be provided by a journeyman.
- b. When such exemptions from the 1-to-5 ratio between apprentices and journeymen are granted to an organization which represents contractors in a specific trade on a local or statewide basis, the member contractors will not be required to submit individual applications for approval to local Joint Apprenticeship Committees, provided they are already covered by the local apprenticeship standards.
- 5. Contractor's Compliance:**
- a. The responsibility of compliance with this Section for all Apprenticeable Trades or Crafts is solely and exclusively that of the Contractor. All decisions of the Joint Apprenticeship Committee(s) under this Section are subject to the provisions of California Labor Code section 3081 and penalties are pursuant to Labor Code section 1777.7 and the determination of the Labor Commissioner.



ATTACHMENT B

Campaign Contribution Disclosure

(SB 1439)

DEFINITIONS

Actively supporting the matter: (a) Communicate directly with a member of the Board of Supervisors or other County elected officer [Sheriff, Assessor-Recorder-Clerk, District Attorney, Auditor-Controller/Treasurer/Tax Collector] for the purpose of influencing the decision on the matter; or (b) testifies or makes an oral statement before the County in a proceeding on the matter for the purpose of influencing the County's decision on the matter; or (c) communicates with County employees, for the purpose of influencing the County's decision on the matter; or (d) when the person/company's agent lobbies in person, testifies in person or otherwise communicates with the Board or County employees for purposes of influencing the County's decision in a matter.

Agent: A third-party individual or firm who, for compensation, is representing a party or a participant in the matter submitted to the Board of Supervisors. If an agent is an employee or member of a third-party law, architectural, engineering or consulting firm, or a similar entity, both the entity and the individual are considered agents.

Otherwise related entity: An otherwise related entity is any for-profit organization/company which does not have a parent-subsidiary relationship but meets one of the following criteria:

- (1) One business entity has a controlling ownership interest in the other business entity;
- (2) there is shared management and control between the entities; or
- (3) a controlling owner (50% or greater interest as a shareholder or as a general partner) in one entity also is a controlling owner in the other entity.

For purposes of (2), "shared management and control" can be found when the same person or substantially the same persons own and manage the two entities; there are common or commingled funds or assets; the business entities share the use of the same offices or employees, or otherwise share activities, resources or personnel on a regular basis; or there is otherwise a regular and close working relationship between the entities.

Parent-Subsidiary Relationship: A parent-subsidiary relationship exists when one corporation has more than 50 percent of the voting power of another corporation.

Contractors must respond to the questions on the following page. If a question does not apply respond N/A or Not Applicable.

1. Name of Contractor: M3 Group Inc. (DBA Mission Mobile Medical Group)
2. Name of Principal (i.e., CEO/President) of Contractor, if the individual actively supports the matter and has a financial interest in the decision:

N/A

3. Name of agent of Contractor:

Company Name	Agent(s)

4. Name of any known lobbyist(s) who actively supports or opposes this matter:

Company Name	Contact
N/A	

5. Name of Subcontractor(s) (including Principal and Agent(s)) that will be providing services/work under the awarded contract if the subcontractor (1) actively supports the matter and (2) has a financial interest in the decision and (3) will be possibly identified in the contract with the County or board governed special district.

Company Name	Subcontractor(s):	Principal and//or Agent(s):
N/A		

6. Is the entity listed in Question No.1 a nonprofit organization under Internal Revenue Code section 501(c)(3)?

Yes

No

7. Name of any known individuals/companies who are not listed in Questions 1-5, but who may (1) actively support or oppose the matter submitted to the Board and (2) have a financial interest in the outcome of the decision:

Company Name	Individual(s) Name

8. Was a campaign contribution, of more than \$250, made to any member of the San Bernardino County Board of Supervisors or other County elected officer on or after January 1, 2023, by any of the individuals or entities listed in Question Nos. 1-7?

No If **no**, please skip Question No. 9.

Yes If **yes**, please continue to complete this form.

9. Name of Board of Supervisor Member or other County elected officer: _____

Name of Contributor: _____

Date(s) of Contribution(s): _____

Amount(s): _____

Please add an additional sheet(s) to identify additional Board Members/County elected officer to whom anyone listed made campaign contributions.

By signing the Contract, Contractor certifies that the statements made herein are true and correct. Contractor understands that the individuals and entities listed in Question Nos. 1-7 are prohibited from making campaign contributions of more than \$250 to any member of the Board of Supervisors or other County elected officer while award of this Contract is being considered and for 12 months after a final decision by the County.

San Bernardino County
Purchasing Department

Invitation to Bid
Class A RV Mobile Health Clinic

No. DPHE24-CO-5354
Page 27 of 28

ATTACHMENT C-VEHICLE SPECIFICATIONS

Chassis	Lar e Dual Medical Exam Rooms	Large Hybrid Dental/Medical Exam Rooms	Lar e Dual Dental Exam Rooms
Class A Remanufactured RV	Solid Surface Countertops	Solid Surface Countertops	Solid Surface Countertops
Hydraulic Leveling System	Solid Plywood/ Laminated Cabinets	Solid Plywood/ Laminated Cabinets	Solid Plywood/ Laminated Cabinets
Hydraulic Slide-outs	Wall Film-wall coverings	Wall Film-wall coverings	Wall Film-wall coverings
Dual 13.5k AC Units	LVT Flooring	LVT Flooring	LVT Flooring
3-Way Vent Fan	Bathroom	Bathroom	Bathroom
LP/Electric Heat	Padded Vinyl Ceiling (white)	Padded Vinyl Ceiling (white)	Padded Vinyl Ceiling (white)
Rear and Side View Cameras			
Mid-Entry	Exam Tables	Exam Tables	
A/C Breaker Panel	Hand Sanitizer/Soap Dispensers	Hand Sanitizer/Soap Dispensers	Hand Sanitizer/Soap Dispensers
D/C Fuse Panel	Paper Towel Holders	Paper Towel Holders	Paper Towel Holders
Battery Isolator Relay	Sharps Containers	Sharps Containers	Sharps Containers
50amp shore power	Expandable Front Exam	Expandable Front Exam	Expandable Front Exam
60-gal Fresh water	12v LED Lighting	12v LED Lighting	12v LED Lighting
	Stainless Steel Sinks	Stainless Steel Sinks	Stainless Steel Sinks
Tank Level Monitoring	Upholstered Waiting Benches	Upholstered Waiting Benches	Upholstered Waiting Benches
Fresh Water Fill	Full Graphic Wrap	Full Graphic Wrap	Full Graphic Wrap
42-gallon grey	ADA Medical Freezer	ADA Medical Freezer	ADA Medical Freezer
42-gallon black	Vaccine Fridge	Vaccine Fridge	Vaccine Fridge
10-gallon LP/Electric Water heater	Microwave	Microwave	
Triton V10	Dental Exam Chair Lights	Dental Exam Chair Lights	Dental Exam Chair Lights
	Dental Treatment Chairs	Dental Treatment Chairs	Dental Treatment Chairs
	Mobile Dental Cart	Mobile Dental Cart	Mobile Dental Cart
	Amalgam Separators	Amalgam Separators	Amalgam Separators

	Lar e Dual Medical Exam Rooms	Large Hybrid Dental/Medical Exam Rooms	Lar e Dual Dental Exam Rooms
Chassis			
Ford Gas		Autoclave	Autoclave
SO-gallon fuel		Ultrasonic	Ultrasonic
Electric Captains Chair		Handheld Dental X-Ray	Handheld Dental X-Ray
Electric Entry Step			
Electric Awning	5.5kw Gen w/ Remote Start	7kw Gen w/ Remote Start	Dual 7kw Gen w/ Remote Start with integrated and redundant power set up
Extra Storage above Drivers Area			
	Min 10 Year Manufacturer's Warranty	Min 10 Year Manufacturer's Warranty	Min 10 Year Manufacturer's Warranty
	Available 24/7 Service and Maintenance	Available 24/7 Service and Maintenance	Available 24/7 Service and Maintenance
Seamless Fiberglass Exterior			
Tubular Aluminum Wall Construction			

Vendors are to provide a Schematic of the vehicle being proposed, both exterior and interior, including vehicle floor plans.

MISSION MOBILE ACADEMY

We continue our promise to keep you on the road through our operator certification course held at our headquarters in Greensboro, NC. Your operator will gain the knowledge and confidence they need to drive and operate your clinic safely. During this two in a half day training, your operator will get classroom instruction, hands on training of setting up and preparing for event and drive mode, safety training, driving, and parking. We also have a fun test at the end.

FAST START COACHING

Four coaching sessions to implement a Mobile Healthcare Solutions plan.

DELIVERY AND ORIENTATION

Our delivery driver will drive to you at the agreed upon location and time frame. On delivery day, our driver will give a full orientation of your clinic and go through your Operations Overview. As we get closer to delivery day, we will want to know how many people will be at the orientation, so we know how much time to allocate. By the time your clinic is delivered, hopefully your operator will have already been to Operator Certification Class.

TIMELINE EXAMPLE

Day 1: Deposit received.

Day 5: Production kickoff

Progress updates will be provided throughout the production process, with your dedicated Project Manager. Additional meetings will be scheduled if needed. After the production kick off, the Project Manager will be responsible for communication, meetings, updates, and project execution. We encourage clients to visit Mission Mobile Medical at any point during the production phase.

Due to the fast nature of our production process, communication is critical. Please indicate to our project manager any critical dates we need to be aware of.

Day 100: Operator training at Mission Mobile Medical HQ

Day 120: Vehicle delivered, Client orientation on-site.

PAYMENT TERMS

50% Down at Time of Contract Signed

25% Progress Payment at Invoiced at 45 Days after Project start.

Final Payment made after inspections and before the clinics are delivered to San Bernardino.

INTERIOR EXAMPLES

The pictures are to show fit and finish and may not reflect your specifications on the final build.

The front room looking toward cab, with curtain separation.



The front room and cab looking back toward the swing wall with slides expanded.



Looking curbside at the entry door and wheelchair lift.

INTERIOR EXAMPLES CONTINUED



Looking toward the back, in the center of the clinic lab space, optional wheelchair lift and bathroom (door on left).



Rear Exam Room

San Bernardino County - Dual Medical

San Bernardino County
385 North Arrowhead Avenue
San Bernardino, CA 92415
United States

Reference: 20240214-115331094

Created: February 14, 2024

Expires: May 30, 2025

Created by: Monica Grashuis

Michael Shin
michael.shin@dph.sbcounty.gov
+1 9098320807

mgrashuis@missionmobilemed.com

+17757418777

Comments from Monica Grashuis

Pricing is based on standard terms and conditions described in Master Service Agreement (MSA).

Client is responsible for all sales tax (if applicable) and registration fees due upon registering the mobile clinic with state authorities. Please ask your Mission Mobile Medical representative for more information.

Products & Services

Item & Description	Quantity	Unit Price	Total
<p>Large Dual Exam Clinic Conversion</p> <p>Remanufactured Ford Gas Chassis</p> <ul style="list-style-type: none"> -Leveling system -Ducted HVAC -Backup camera <p>Clinic</p> <ul style="list-style-type: none"> -Dual exam rooms -Patient waiting/intake -Bathroom -Lab area, with sink -Solid-surface countertops and medical-grade cabinetry, locking -Medical-grade furniture and equipment -12V LED lighting -Exterior vinyl graphics, design and installation 	1	\$339,608.00	\$339,608.00
<p>Standard Refrigerator</p> <p>Non-Medical</p>	1	\$818.44	\$818.44
<p>Staff Microwave</p>	1	\$300.00	\$300.00
<p>Internet Connection Package</p> <p>Wi-Fi Network:</p> <ul style="list-style-type: none"> - labor and materials to establish a functional Wi-Fi network onboard - dual-provider cellular network (max 15 connected users) - signal redundancy/failover capability - utilizes Cradlepoint IBR900 (Cat-18 modem) Gigabit-Class LTE router - 940Mbps firewall throughput with dual-concurrent Wi-Fi. - can be upgraded to 5G - NOTE: client to provide an activated Sim during production process 	1	\$4,880.40	\$4,880.40
<p>Medical Refrigerator/Freezer</p>	1	\$7,500.00	\$7,500.00
<p>Fast Start Package</p> <p>Four Working Sessions with a Mobile Healthcare Solutions Program Planner</p>	1	\$0.00	\$0.00

Item & Description	Quantity	Unit Price	Total
Service & Maintenance Support Twenty-four (24) months - Preventative Maintenance Management (scheduling, coordination) - On-call technical assistance with a nationwide network of vendors - Additional services available beyond initial term - Management of the pre-paid management fund	1	\$5,000.00	\$5,000.00
10 Year Warranty Ten (10) Year Extended Warranty - Chassis & Drivetrain - Fabricated components - Wear components - Generator, graphics limited to 1 year - Maintenance required to maintain coverage, see warranty schedule for coverage details	1	\$0.00	\$0.00
Training and Delivery Training: Three (3) day comprehensive Academy training, Greensboro, NC - one (1) Academy seat included [1 person] - additional Academy seats available [\$3,500 per person] Delivery: transport to client location, with equipment orientation	1	\$5,453.00	\$5,453.00
Insurance and Doc Fees - Pass through costs for admin time and registering the vehicle on MMM liability insurance while on premises	1	\$1,167.00	\$1,167.00
One-time subtotal			\$364,726.84
Total			\$364,726.84

Purchase terms

50% Due at Signing

25% Due at 45 Days

Final Payment Due Before Delivery

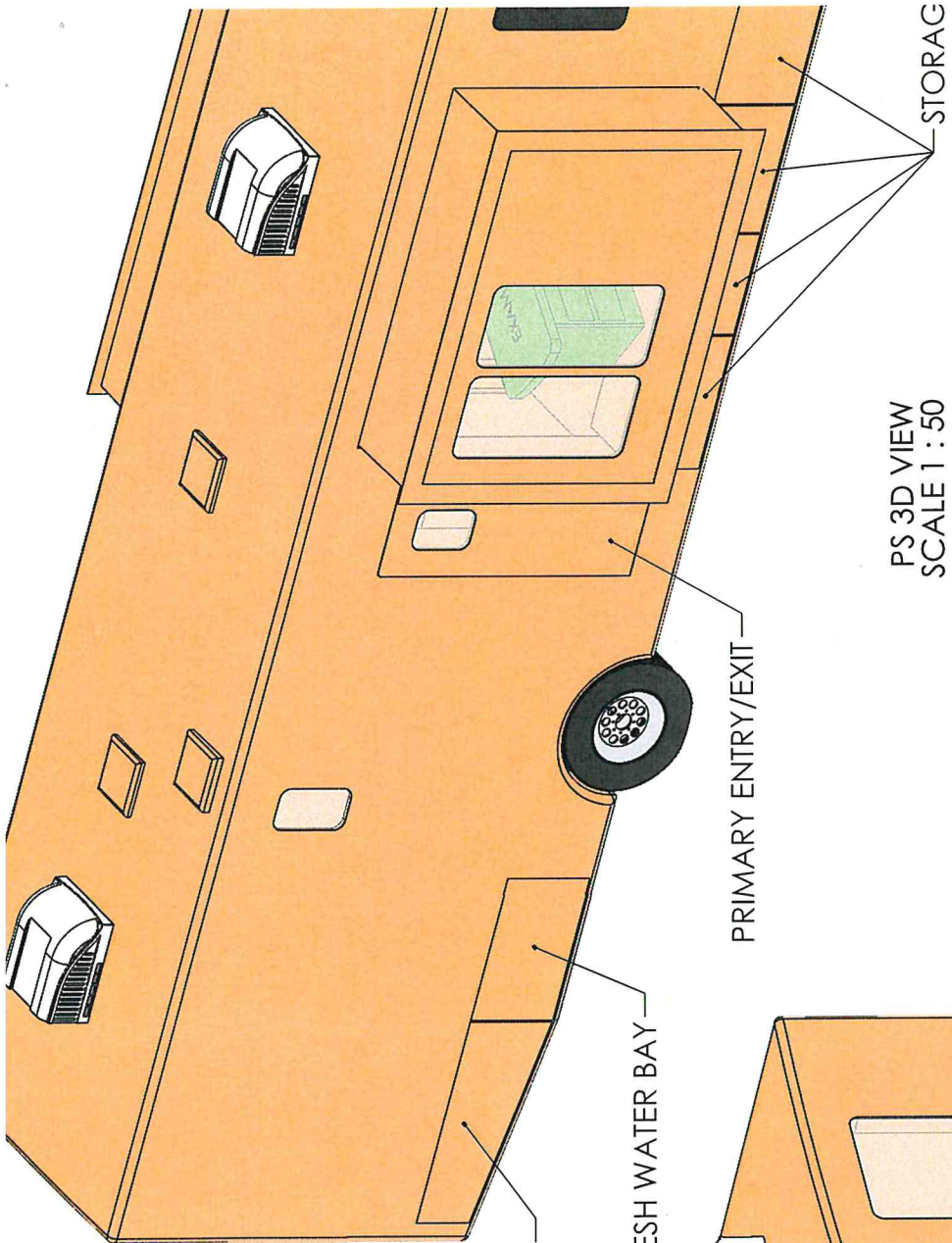

PS 3D VIEW
SCALE 1 : 50

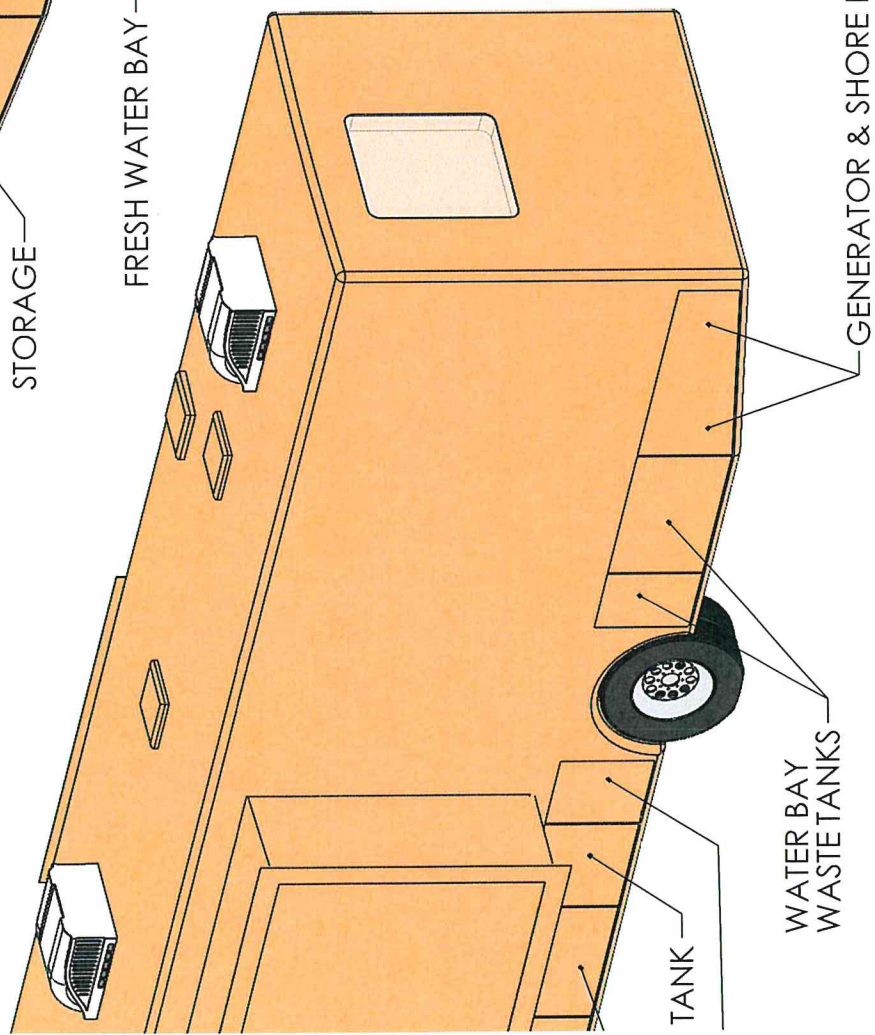

DS 3D VIEW
SCALE 1 : 50

NOTE: F

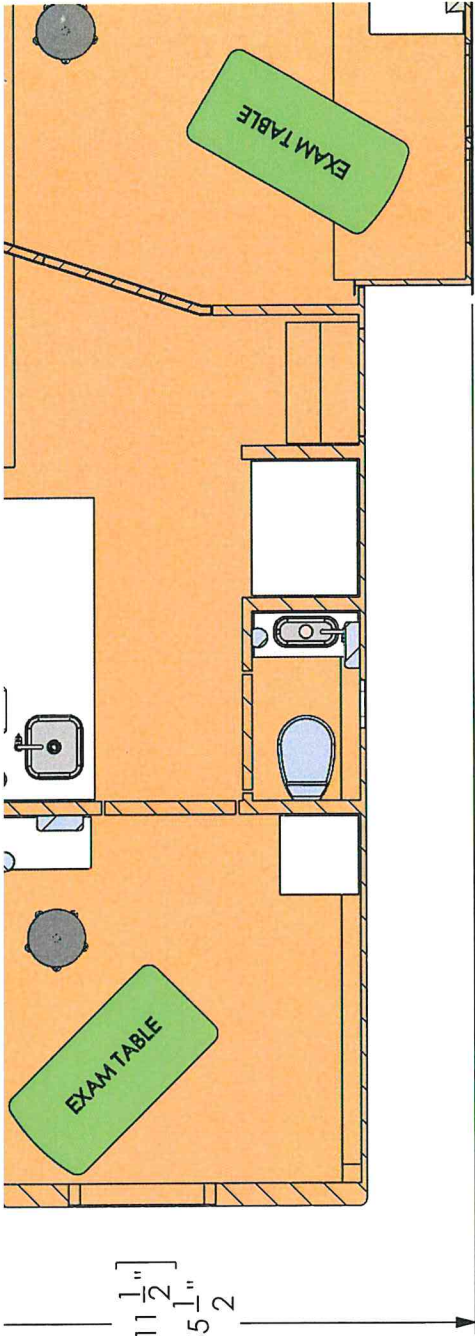

SECTION A-A
SCALE 1 : 50

[37]
444"

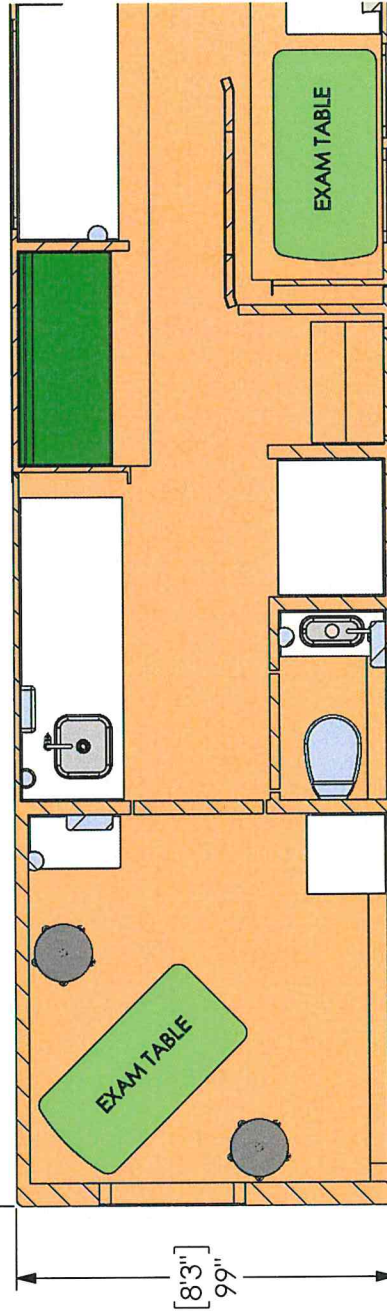

SECTION B-B
SCALE 1 : 50

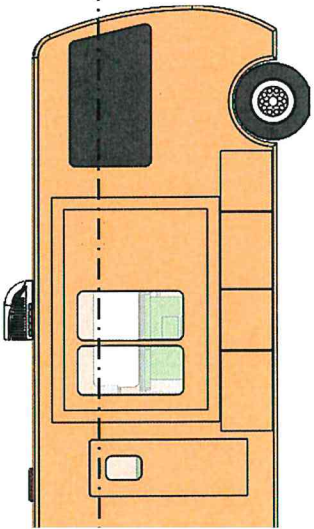

VIEW OPEN

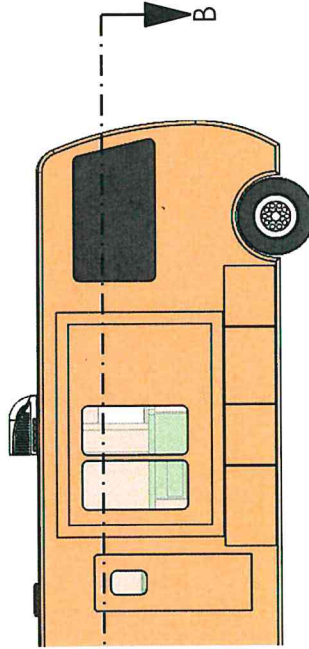

VIEW CLOSED

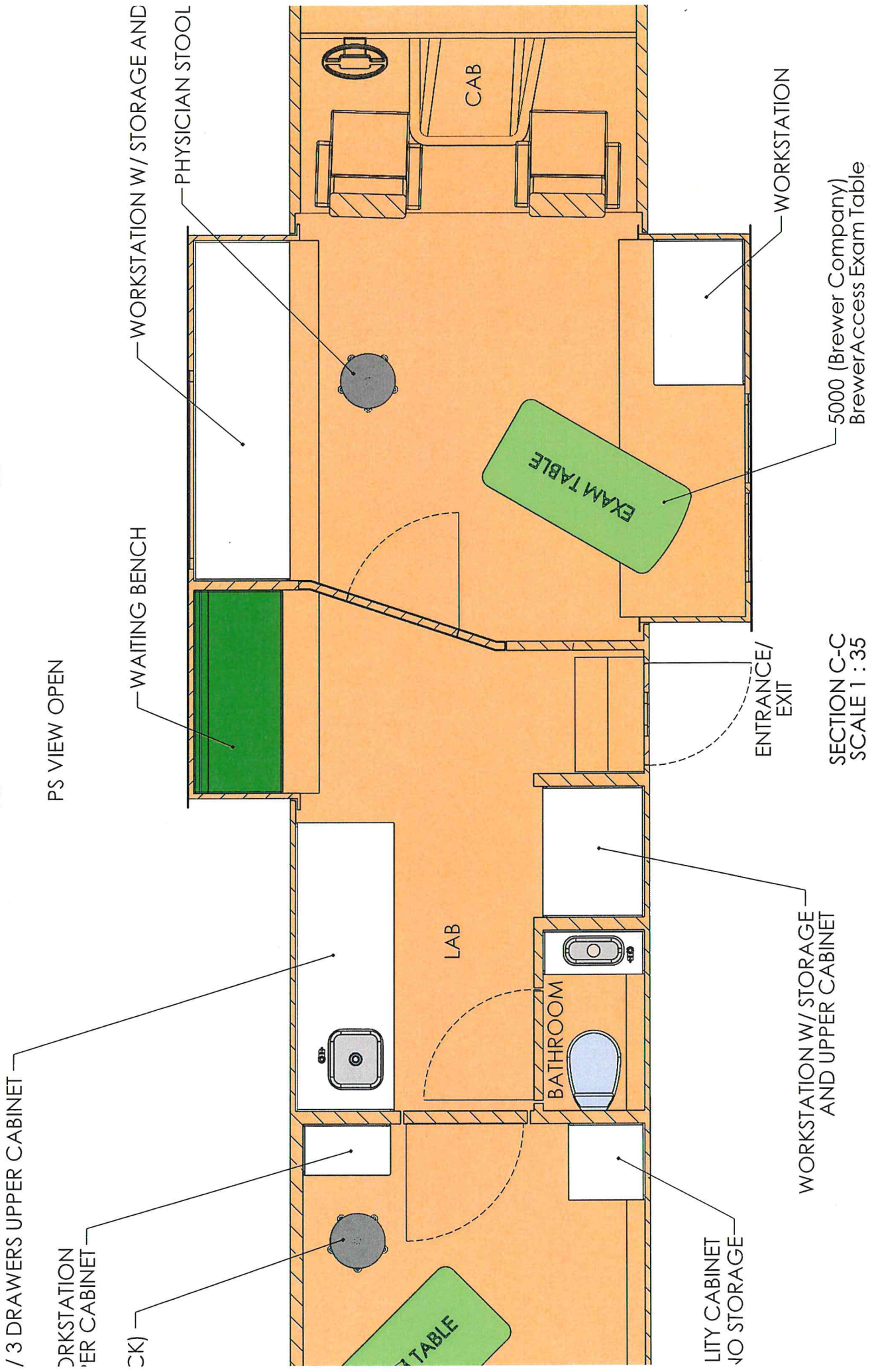
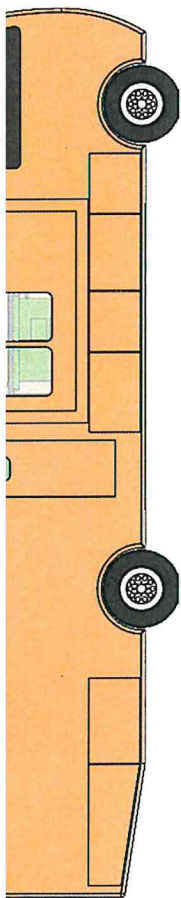

3 DRAWERS UPPER CABINET

WORKSTATION W/ STORAGE AND UPPER CABINET

CK)

WAITING BENCH

WORKSTATION W/ STORAGE AND

PHYSICIAN STOOL

LAB

BATHROOM

CAB

EXAM TABLE

ENTRANCE/EXIT

5000 (Brewer Company) BrewerAccess Exam Table

LITY CABINET NO STORAGE

WORKSTATION W/ STORAGE AND UPPER CABINET

SECTION C-C
SCALE 1 : 35

San Bernardino County - Dual Dental

San Bernardino County
385 North Arrowhead Avenue
San Bernardino, CA 92415
United States

Michael Shin
michael.shin@dph.sbcounty.gov
+19098320807

Reference: 20240515-113020083

Created: May 15, 2024

Expires: May 30, 2025

Created by: Monica Grashuis

mgrashuis@missionmobilemed.com

+17757418777

Comments from Monica Grashuis

Pricing is based on standard terms and conditions described in Master Service Agreement (MSA).

Client is responsible for all sales tax (if applicable) and registration fees due upon registering the mobile clinic with state authorities.

Products & Services

Item & Description	Quantity	Unit Price	Total
<p>Large Dual Operatory Dental Clinic Conversion</p> <p>Remanufactured Ford Gas Chassis</p> <ul style="list-style-type: none"> -Leveling system -Ducted HVAC -Backup camera <p>Clinic</p> <ul style="list-style-type: none"> -Patient waiting/intake at entry -Bathroom -Lab areas with sinks -Solid-surface countertops and cabinetry, locking storage -90-3100NB Elevate ASI Dental Treatment Chair -90-2021 ASI Right-handed Mobile Dental Delivery System -44400 Welch Allyn GS 300 Exam Light -Provider Stools -Assistant Stools -12V LED lighting -2nd generator -Exterior vinyl graphics, design and install 	1	\$430,275.00	\$430,275.00
<p>Dental Accessories Package</p> <ul style="list-style-type: none"> -UX-08895-05 Cole Parmer Ultrasonic Cleaner -S500 Wayne Metal Products Dry Heat Electric Sterilizer -Nomad handheld X-Ray with Sensor 	1	\$26,749.00	\$26,749.00
<p>Medical Freezer</p>	1	\$3,500.00	\$3,500.00
<p>Internet Connection Package</p> <p>Wi-Fi Network:</p> <ul style="list-style-type: none"> - labor and materials to establish a functional Wi-Fi network onboard - dual-provider cellular network (max 15 connected users) - signal redundancy/failover capability - utilizes Cradlepoint IBR900 (Cat-18 modem) Gigabit-Class LTE router - 940Mbps firewall throughput with dual-concurrent Wi-Fi. - can be upgraded to 5G - NOTE: client to provide an activated Sim during production process 	1	\$4,880.40	\$4,880.40

Item & Description	Quantity	Unit Price	Total
<p>Fast Start Package</p> <p>Four working sessions with an experienced Mobile Healthcare Solutions program consultant. These sessions will ensure a fast start and solid foundation for a long-term mobile health program.</p>	1	\$0.00	\$0.00
<p>Prepaid Service and Maintenance Plan</p> <p>Allocation of \$7,500 per year for two years to cover service and maintenance needs.</p> <p>Surplus budget will be rolled into future years, assuming the service and maintenance support is extended as well.</p> <p>Incremental maintenance costs beyond the budget will be invoiced at cost plus 25%.</p>	1	\$15,000.00	\$15,000.00
<p>Service & Maintenance Support</p> <p>Twenty-four (24) months</p> <ul style="list-style-type: none"> - Preventative Maintenance Management (scheduling, coordination) - On-call technical assistance with a nationwide network of vendors - Additional services available beyond initial term - Management of the pre-paid management fund 	1	\$5,000.00	\$5,000.00
<p>Training and Delivery</p> <p>Training: Three (3) day comprehensive Academy training, Greensboro, NC</p> <ul style="list-style-type: none"> - one (1) Academy seat included [1 person] - additional Academy seats available [\$3,500 per person] <p>Delivery: transport to client location, with equipment orientation</p>	1	\$5,453.00	\$5,453.00
<p>10 Year Warranty</p> <p>Ten (10) Year Extended Warranty</p> <ul style="list-style-type: none"> - Chassis & Drivetrain - Fabricated components - Wear components - Generator, graphics limited to 1 year - Maintenance required to maintain coverage, see warranty schedule for coverage details 	1	\$0.00	\$0.00
<p>Insurance and Doc Fees</p> <ul style="list-style-type: none"> - Pass through costs for admin time and registering the vehicle on MMM liability insurance while on premises 	1	\$1,167.00	\$1,167.00
One-time subtotal			\$492,024.40
Total			\$492,024.40

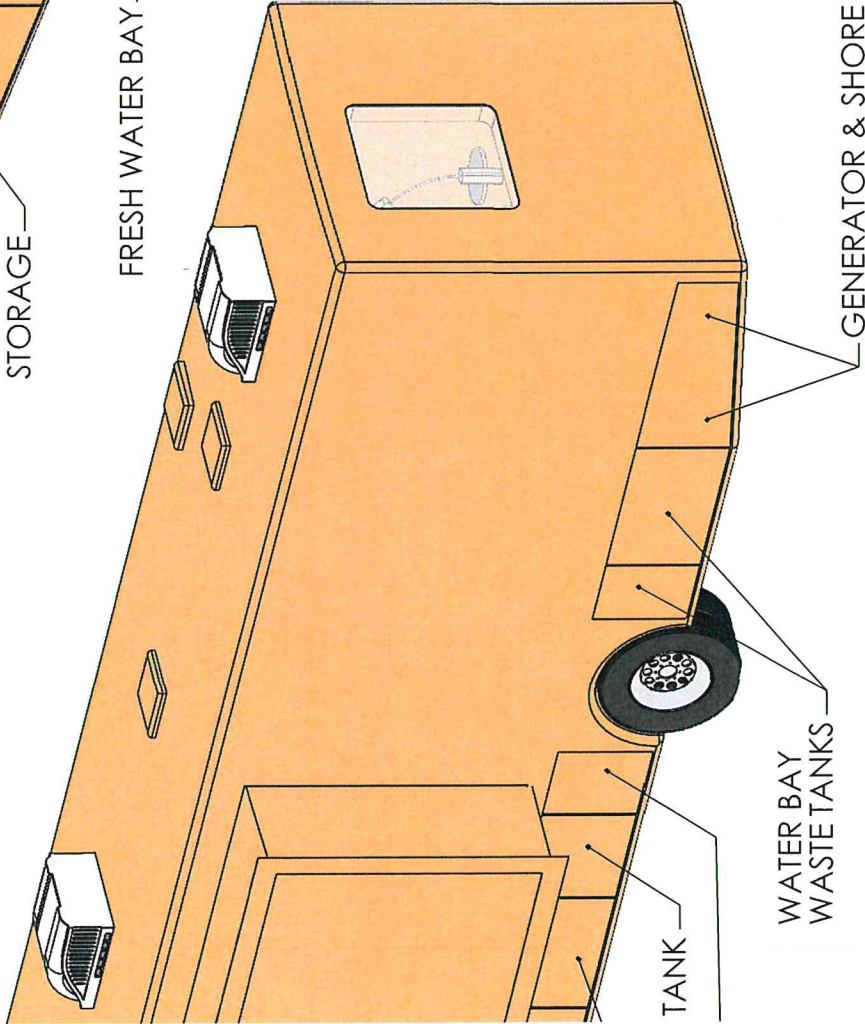
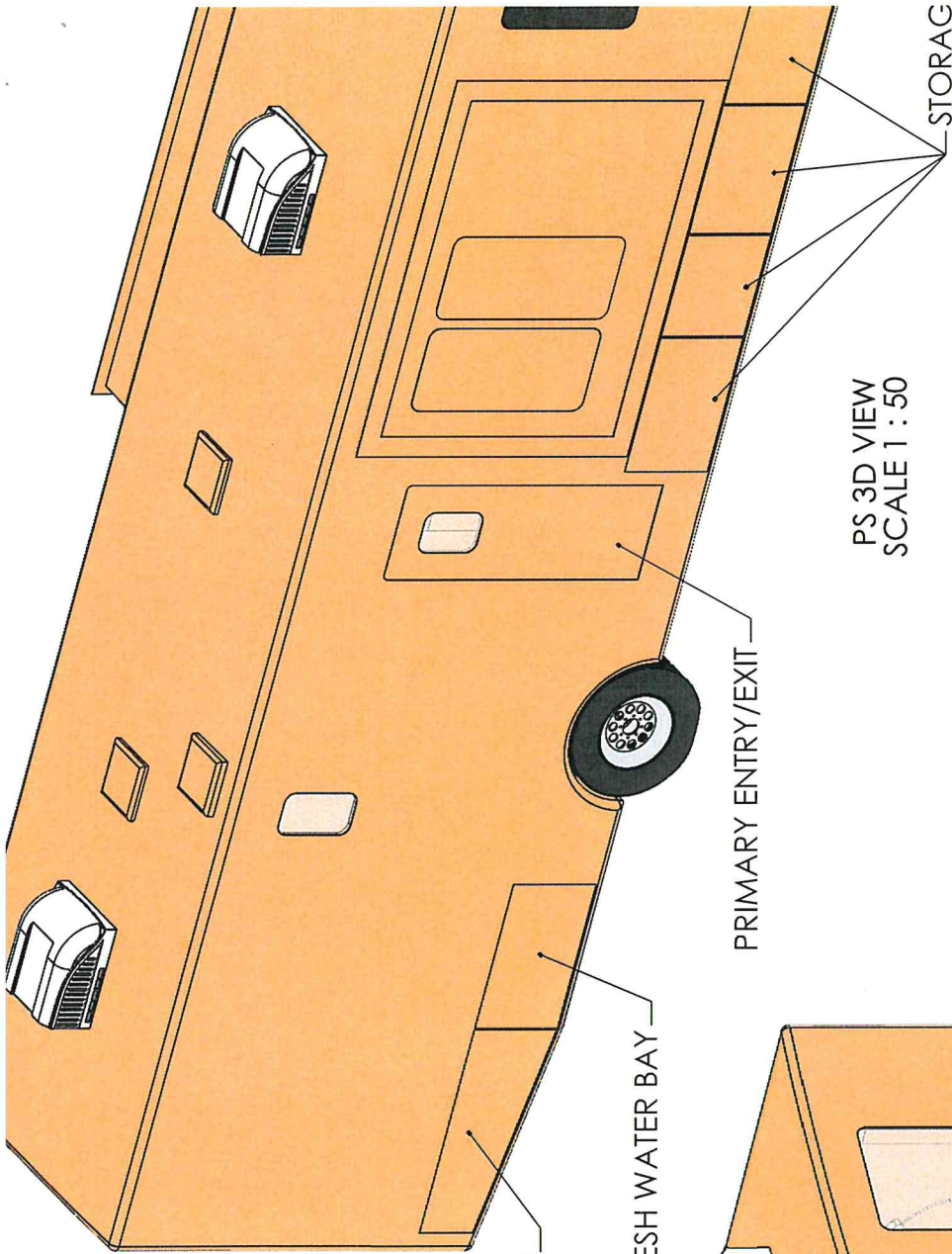

DS 3D VIEW
SCALE 1 : 50

NOTE: f

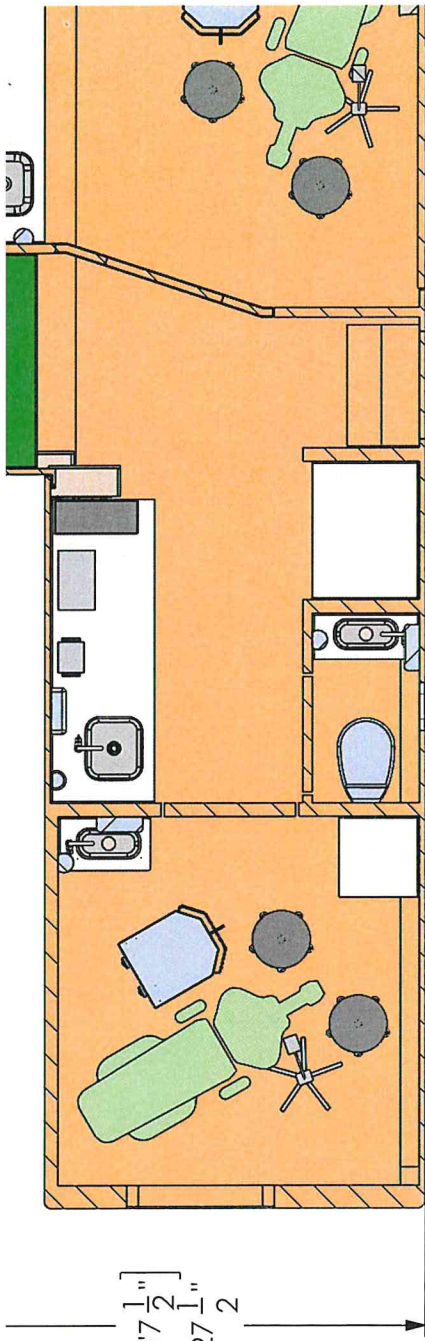

SECTION A-A
SCALE 1 : 50

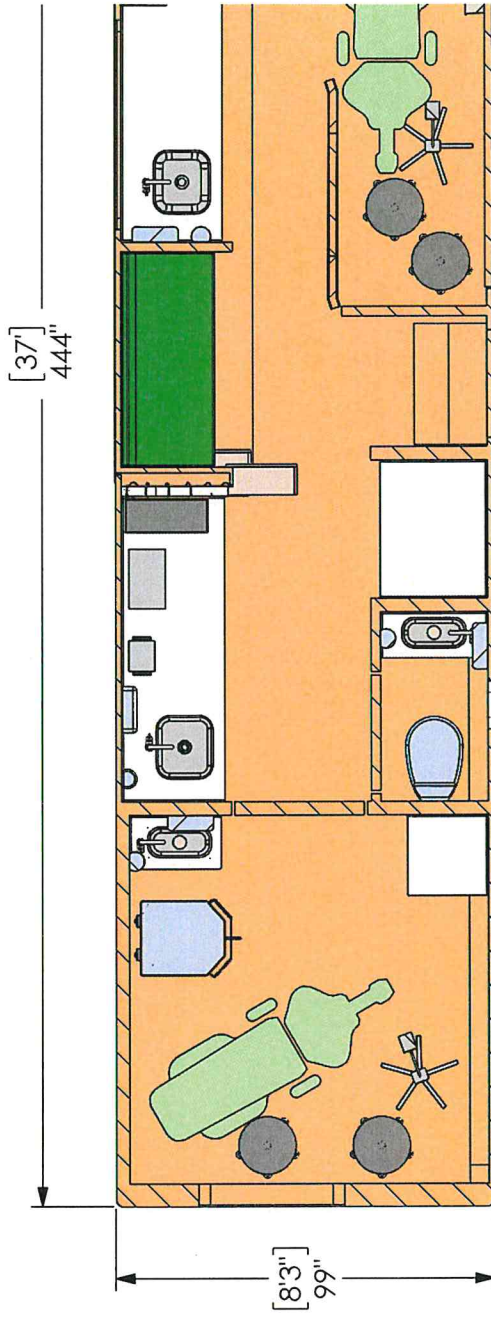

SECTION B-B
SCALE 1 : 50

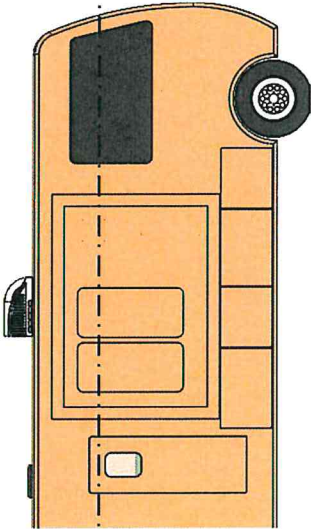

VIEW OPEN

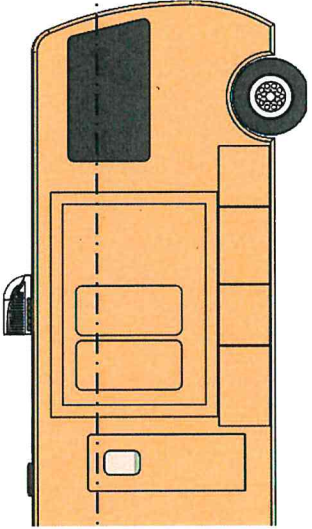

VIEW CLOSED

San Bernardino County - Dual Hybrid

San Bernardino County
385 North Arrowhead Avenue
San Bernardino, CA 92415
United States

Michael Shin
michael.shin@dph.sbcounty.gov
+19098320807

Reference: 20240515-113730191

Created: May 15, 2024

Expires: May 30, 2025

Created by: Monica Grashuis

mgrashuis@missionmobilemed.com

+17757418777

Comments from Monica Grashuis

Pricing is based on standard terms and conditions described in Master Service Agreement (MSA).

Client is responsible for all sales tax (if applicable) and registration fees due upon registering the mobile clinic with state authorities.

Products & Services

Item & Description	Quantity	Unit Price	Total
Large Dual Exam Clinic Conversion	1	\$339,608.00	\$339,608.00
Remanufactured Ford Gas Chassis			
-Leveling system			
-Ducted HVAC			
-Backup camera			
Clinic			
-Dual exam rooms			
-Patient waiting/intake			
-Bathroom			
-Lab area, with sink			
-Solid-surface countertops and medical-grade cabinetry, locking			
-Medical-grade furniture and equipment			
-12V LED lighting			
-Exterior vinyl graphics, design and installation			
One Room Dental Package	1	\$36,250.00	\$36,250.00
-90-3100NB Elevate ASI Dental Treatment Chair			
-90-2021 ASI Right-handed Mobile Dental Delivery System			
-Welch Allyn Exam Light			
-Dentist Stool			
-Dental Assistant Stool			
Dental Accessories Package	1	\$26,749.00	\$26,749.00
-UX-08895-05 Cole Parmer Ultrasonic Cleaner			
-S500 Wayne Metal Products Dry Heat Electric Sterilizer			
-Nomad handheld X-Ray with Sensor			
Medical Refrigerator/Freezer	1	\$7,500.00	\$7,500.00
Staff Microwave	1	\$300.00	\$300.00

Item & Description	Quantity	Unit Price	Total
<p>Internet Connection Package</p> <p>Wi-Fi Network:</p> <ul style="list-style-type: none"> - labor and materials to establish a functional Wi-Fi network onboard - dual-provider cellular network (max 15 connected users) - signal redundancy/failover capability - utilizes Cradlepoint IBR900 (Cat-18 modem) Gigabit-Class LTE router - 940Mbps firewall throughput with dual-concurrent Wi-Fi. - can be upgraded to 5G - NOTE: client to provide an activated Sim during production process 	1	\$4,880.40	\$4,880.40
<p>Fast Start Package</p> <p>Four working sessions with an experienced Mobile Healthcare Solutions program consultant. These sessions will ensure a fast start and solid foundation for a long-term mobile health program.</p>	1	\$0.00	\$0.00
<p>Prepaid Service and Maintenance Plan</p> <p>Allocation of \$7,500 per year for two years to cover service and maintenance needs.</p> <p>Surplus budget will be rolled into future years, assuming the service and maintenance support is extended as well.</p> <p>Incremental maintenance costs beyond the budget will be invoiced at cost plus 25%.</p>	1	\$15,000.00	\$15,000.00
<p>Service & Maintenance Support</p> <p>Twenty-four (24) months</p> <ul style="list-style-type: none"> - Preventative Maintenance Management (scheduling, coordination) - On-call technical assistance with a nationwide network of vendors - Additional services available beyond initial term - Management of the pre-paid management fund 	1	\$5,000.00	\$5,000.00
<p>Training and Delivery</p> <p>Training: Three (3) day comprehensive Academy training, Greensboro, NC</p> <ul style="list-style-type: none"> - one (1) Academy seat included [1 person] - additional Academy seats available [\$3,500 per person] <p>Delivery: transport to client location, with equipment orientation</p>	1	\$5,453.00	\$5,453.00

Item & Description	Quantity	Unit Price	Total
10 Year Warranty Ten (10) Year Extended Warranty - Chassis & Drivetrain - Fabricated components - Wear components - Generator, graphics limited to 1 year - Maintenance required to maintain coverage, see warranty schedule for coverage details	1	\$0.00	\$0.00
Insurance and Doc Fees - Pass through costs for admin time and registering the vehicle on MMM liability insurance while on premises	1	\$1,167.00	\$1,167.00
		One-time subtotal	\$441,907.40
		Total	\$441,907.40

Purchase terms

50% Due at Signing

25% Due at 45 Days

Final Payment Due Before Delivery

Questions? Contact me



Monica Grashuis

mgrashuis@missionmobilemed.com

+17757418777

Mission Mobile Medical Group, Inc.

7700 Boeing Drive

Greensboro, North Carolina 27409

United States

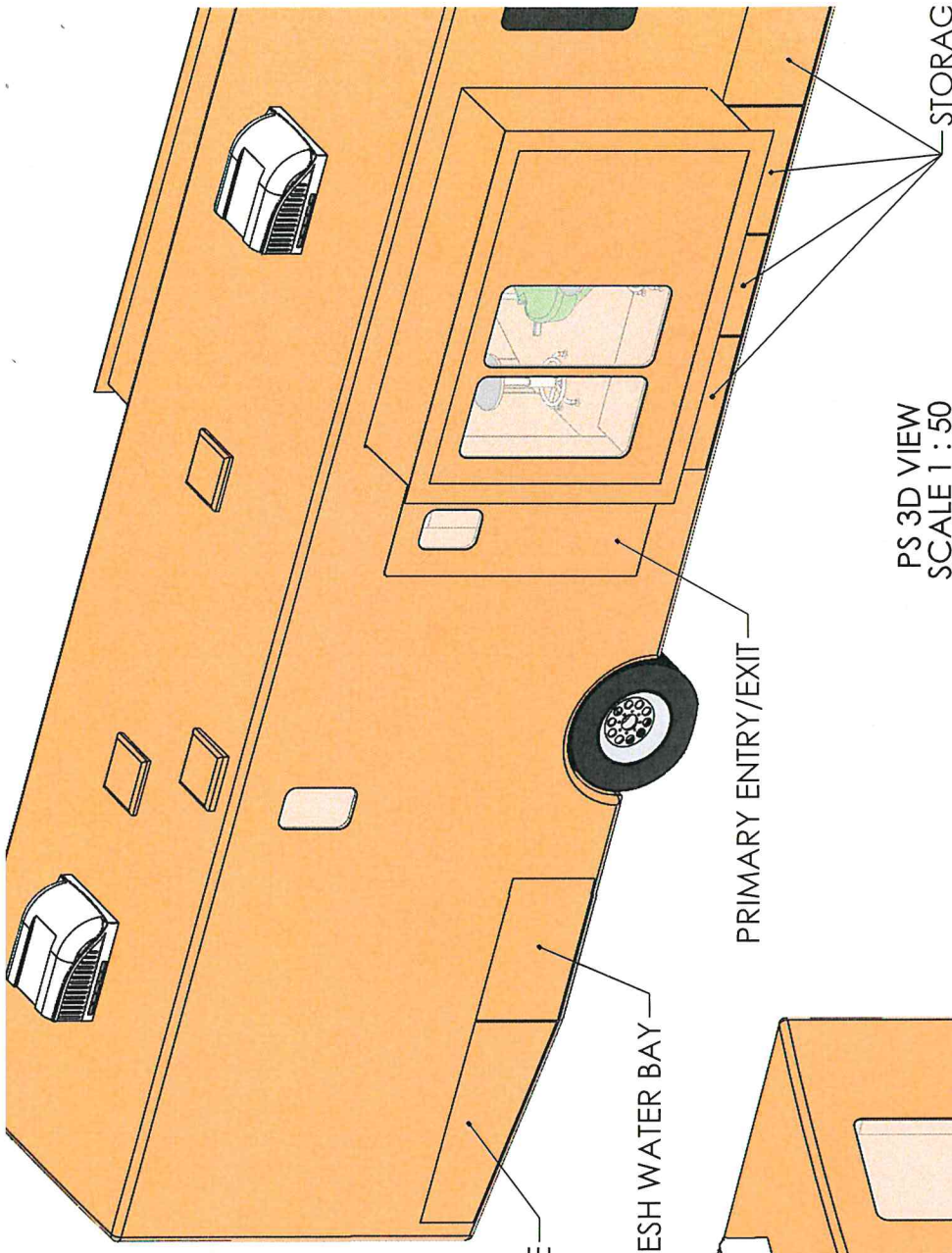

PS 3D VIEW
SCALE 1 : 50

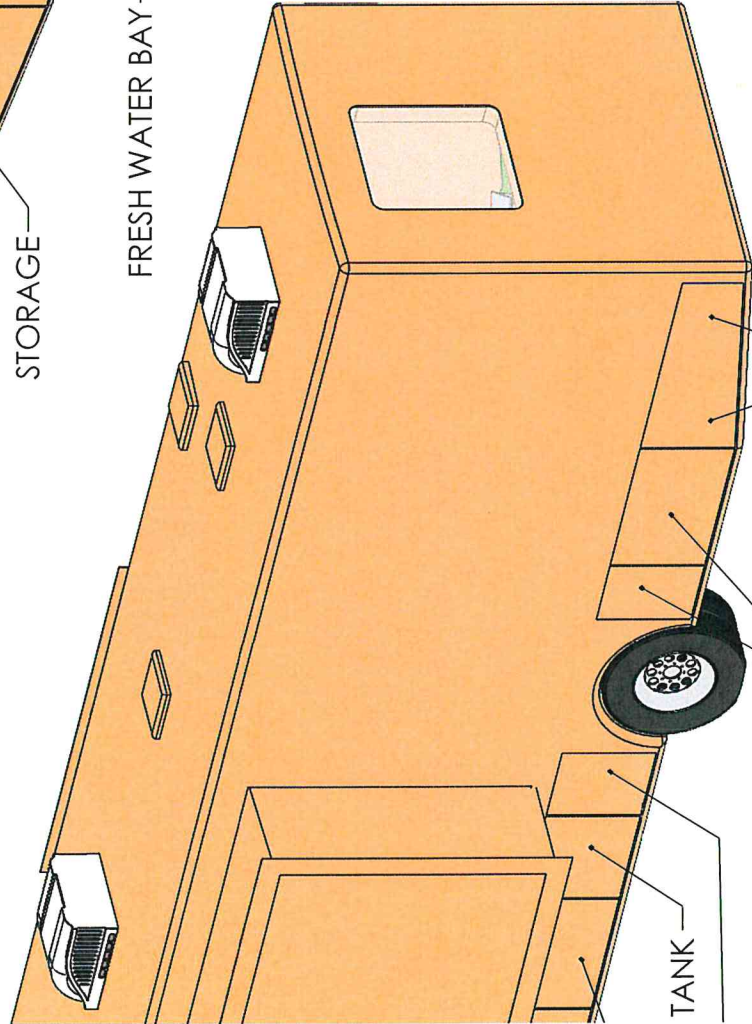

DS 3D VIEW
SCALE 1 : 50

NOTE: F

[121 1/2"]
155 1/2"

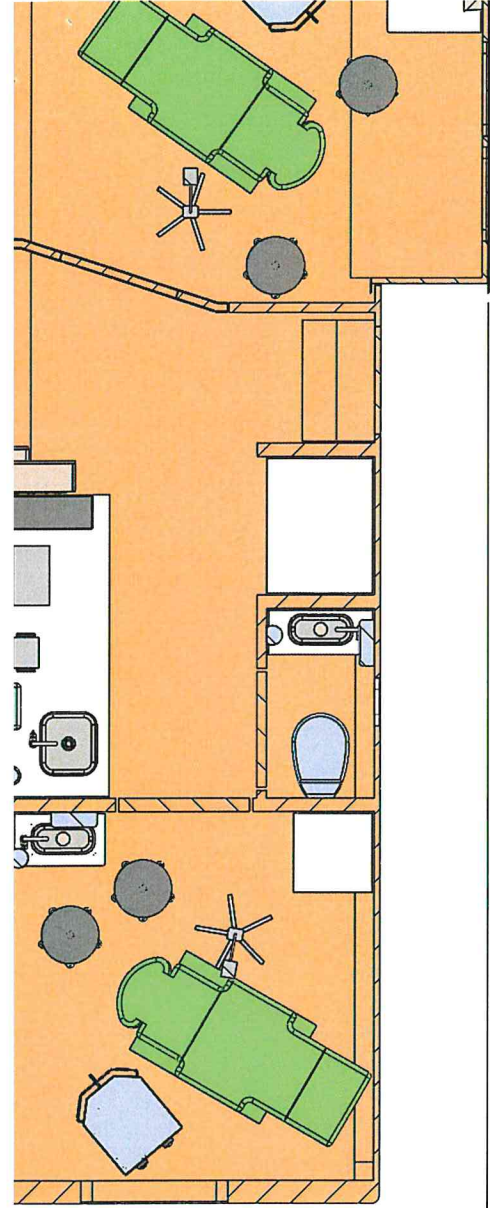

VIEW OPEN

SECTION A-A
SCALE 1 : 50

[37']
444"

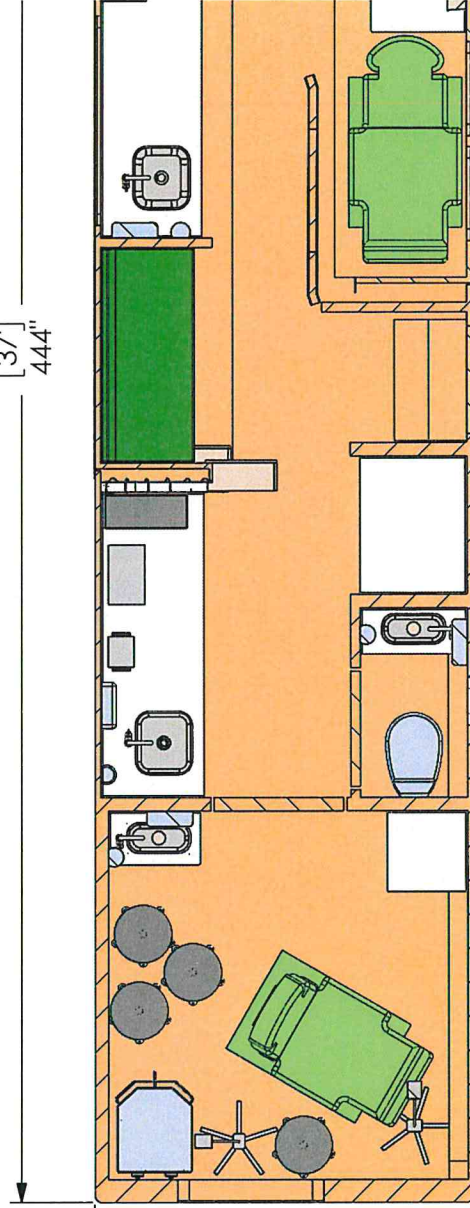

SECTION B-B
SCALE 1 : 50

[83"]
99"

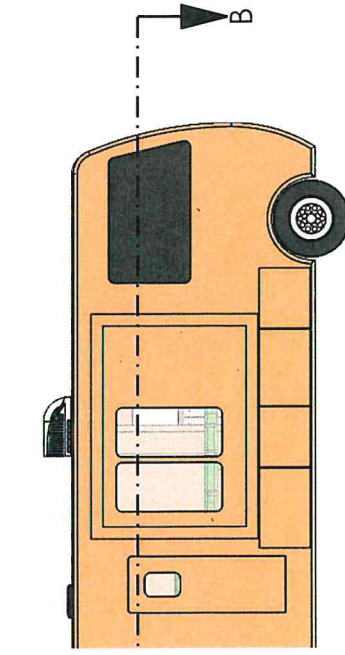

VIEW CLOSED

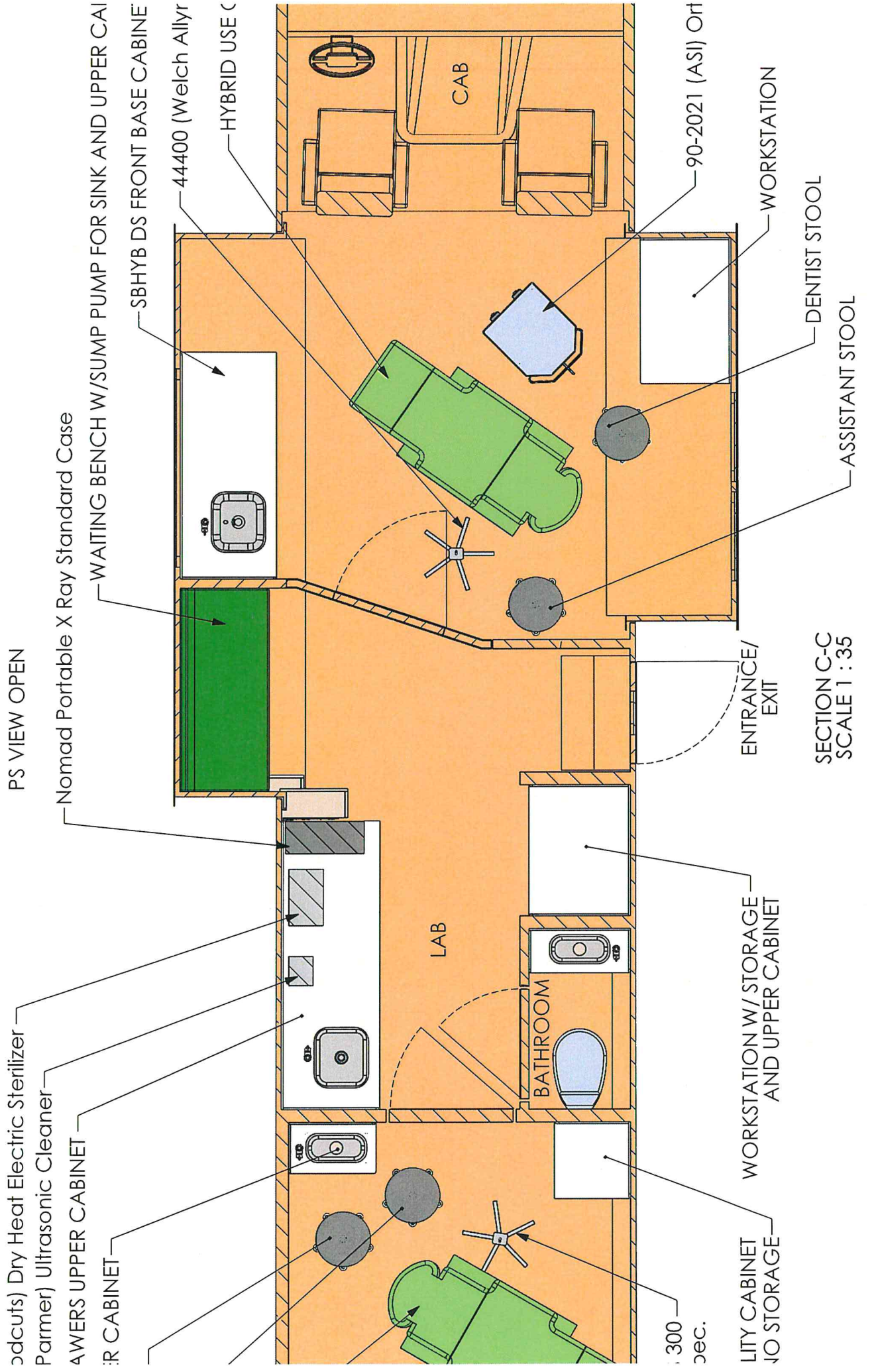
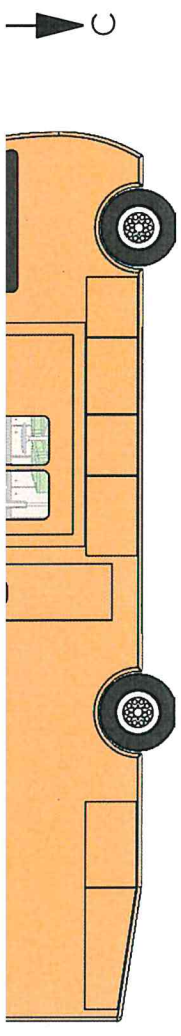

(cuts) Dry Heat Electric Sterilizer
 (Parmer) Ultrasonic Cleaner
 AWERS UPPER CABINET
 ER CABINET

PS VIEW OPEN

Nomad Portable X Ray Standard Case
 WAITING BENCH W/SUMP PUMP FOR SINK AND UPPER CAI
 SBHYB DS FRONT BASE CABINE
 44400 (Welch Allyr
 HYBRID USE C

LAB

BATHROOM

300
dec.

WORKSTATION W/ STORAGE
 AND UPPER CABINET

LITY CABINET
 O STORAGE

ENTRANCE/
EXIT

SECTION C-C
 SCALE 1 : 35

90-2021 (ASJ) Ort
 WORKSTATION
 DENTIST STOOL
 ASSISTANT STOOL