

LEASE AGREEMENT

BETWEEN

**1250 FAIRFAX, LLC AND 521 EAST 11th ST, LLC
DBA: THREE CARNEGIE PLAZA
11726 MONTANA AVE, SUITE 10
LOS ANGELES, CA 90049**

AS LANDLORD

AND

SAN BERNARDINO COUNTY

AS TENANT

for certain premises at

**735 EAST CARNEGIE DRIVE
SUITE 200
SAN BERNARDINO, CA 92408**

LEASE AGREEMENT

In consideration of the mutual covenants contained in the Lease Agreement (“Lease”) and for other good and valuation consideration, the receipt and sufficiency of which is hereby acknowledged by the parties, this Lease dated July 23, 2024 (the “Effective Date”) by and between 1250 Fairfax, LLC and 521 East 11th St, LLC; dba Three Carnegie Plaza (“LANDLORD”), as landlord, and San Bernardino County (“COUNTY”), as tenant, agree on the terms and conditions set forth in the Lease.

SECTION I – BASIC LEASE PROVISIONS

The following basic lease provisions (“Basic Lease Provisions”) are hereby made a part of the Lease and incorporated herein for the purpose of setting forth the meanings of certain terms in the Lease. In the event of any conflict between terms in the Basic Lease Provisions and the provisions in Section II – Lease Provisions, the provisions in Section II – Lease Provisions shall govern.

- | | | |
|----|-------------------|--|
| A. | LANDLORD | 1250 Fairfax, LLC, a California limited liability company, and 521 East 11th St, LLC, a California limited liability company, collectively dba Three Carnegie Plaza |
| B. | COUNTY | San Bernardino County (“COUNTY”) |
| C. | PROPERTY | Certain real property, comprising the grounds and all improvements thereon (whether now or subsequently existing) located in the City of San Bernardino, County of San Bernardino, commonly known as APN #0281-361-26-0000 |
| D. | BUILDING | The building located on the Property with an address of 735 East Carnegie Drive, Suite 200, San Bernardino (“Building”) |
| E. | PREMISES | A total of approximately 13,168 square feet, located at 735 East Carnegie Drive, Suite 200, San Bernardino, CA 92408 (the “Premises”) as defined in “Exhibit A”. |
| F. | PERMITTED USE | General office use |
| G. | ALLOCATED PARKING | Shared use parking spaces, not to exceed 4:1000 |
| H. | LEASE TERM | Ten (10) Years, commencing on Landlord’s delivery of notice of Substantial Completion subject to punch list items, or the later of the occurrences listed below under Commencement Date, and expiring on the Expiration Date unless earlier terminated in accordance with the Lease |
| I. | COMMENCEMENT DATE | The date the latest of the following occurs: (i) LANDLORD’s delivery of notice of Substantial Completion of the Improvements, subject to punch list items as mutually agreed by the Parties, in accordance with Exhibit B, Improvement Work Letter, Exhibit B-1, Floorplan, Exhibit “B-2”, Improvements Standards and Specifications, and this Lease; (ii) COUNTY’s receipt of a temporary certificate of occupancy for the Premises, and if applicable, the Building and the Property, issued by all relevant governmental authorities, and (iii) written acceptance by an authorized agent of COUNTY for the Improvements for COUNTY’s intended use, subject to punch list items and latent defects, as well as the representations, warranties, and provisions of the Lease, which acceptance shall not be unreasonably withheld, conditioned or delayed (the “Commencement Date”). |

J. EXPIRATION DATE One Hundred Twenty (120) full months from the Commencement Date

K. MONTHLY RENT FOR PREMISES

Period During Lease Term	Monthly Rent	Monthly Amortization of Improvements	Total Monthly Rent
Months 1 - 12	\$28,311.20	\$8,032.48	\$36,343.68
Months 13 - 24	\$29,160.54	\$8,032.48	\$37,193.02
Months 25 – 36	\$30,035.35	\$8,032.48	\$38,067.83
Months 37 – 48	\$30,936.41	\$8,032.48	\$38,968.89
Months 49 – 60	\$31,864.51	\$8,032.48	\$39,896.99
Months 61 – 72	\$32,820.44	\$8,032.48	\$40,852.92
Months 73 – 84	\$33,805.05	\$8,032.48	\$41,837.53
Months 85 – 96	\$34,819.20	\$8,032.48	\$42,851.68
Months 97 - 108	\$35,863.78	\$8,032.48	\$43,896.26
Months 109 – 120	\$36,939.69	\$8,032.48	\$44,972.17

* Dates subject to change based on "Commencement Date"

L. OPTION TO EXTEND LEASE TERM COUNTY shall have the right, at its option, to extend the Lease Term for two (2) additional terms of five (5) years each, subject to Paragraph 7 of the Lease

M. EARLY TERMINATION OPTION At any time during or after the eighth (8) year of the Lease Term, if at all, the COUNTY, in its sole discretion, determines it would be in COUNTY's best interests to terminate the Lease, COUNTY shall have the right, its option, to terminate the Lease as to the Premises or any portion thereof by providing not less than one-hundred eighty (180) days prior written notice of the effective termination date to LANDLORD, subject to Paragraph 8

N. IMPROVEMENTS LANDLORD shall, at its sole cost and expense, complete the Improvements in accordance with the Exhibit "B", Improvement Work Letter the Floor Plan attached hereto and made a part hereof as "Exhibit "B-1", the Improvement Standards and Specifications attached hereto and made a part hereof as "Exhibit "B-2", and the relevant provisions of the Lease on or before the Projected Occupancy Date. LANDLORD shall contribute a Tenant Improvement allowance in the amount of \$197,520.00 (\$15.00 per square foot) to COUNTY. Tenant Improvement allowance to be applied to mutually approved COUNTY specifications. Any costs exceeding the allowance, up to an additional \$50.00 PSF will be amortized and paid by COUNTY at \$0.61 per square foot throughout the term of the Lease as specified in the monthly rent for the premises (Section I, Paragraph K).

O. LANDLORD'S NOTICE ADDRESS 1250 Fairfax, LLC, a California limited liability company, and 521 East 11th St, LLC, a California limited liability company, collectively dba Three Carnegie Plaza
Attn:
Asset Manager
606 South Olive Street, Suite 600
Los Angeles, CA 90014

P. COUNTY'S
NOTICE
ADDRESS

San Bernardino County
Attn: Real Estate Services Department
385 N. Arrowhead Avenue, Third Floor
San Bernardino, CA 92415

with a copy to:

San Bernardino County
Attn: Child Family Services Department
31 W. Stuart Ave
Redlands, CA 92374

Q. EXHIBITS

Exhibit "A"	Premises
Exhibit "A-1"	Site Plan
Exhibit "B"	Improvement Work Letter
Exhibit "B-1"	Floorplan
Exhibit "B-2"	Premises Design Standards and Specifications
Exhibit "C"	Commencement Date Certificate
Exhibit "D"	Reserved
Exhibit "E"	Form of Estoppel Certificate
Exhibit "F"	Form of Subordination, Non-disturbance, and Attornment
Exhibit "G"	List of Former County Officials
Exhibit "H"	Prevailing Wage Requirements
Exhibit "I"	Campaign Contribution Disclosure (SB 1439)

SECTION II – LEASE PROVISIONS

1. **PARTIES.** The parties to the Lease are LANDLORD, as landlord, and COUNTY, as tenant (each a “Party” and collectively, “Parties”), as each Party is set forth in the Basic Lease Provisions. LANDLORD represents and warrants to COUNTY that LANDLORD is the legal owner with sole fee simple title to the Property, including, but not limited to, the Premises, and has the right to enter into the Lease without consent or approval from any other party or parties. In the event of a breach of the foregoing representation and warranty, COUNTY shall have the right to terminate the Lease with immediate effect upon written notice to LANDLORD and LANDLORD shall indemnify, defend (with counsel reasonably approved by COUNTY), and hold harmless COUNTY and its officers, employees, agents, and volunteers from any and all claims, actions, losses, damages and/or liability arising out of or related to said breach. LANDLORD’s indemnity shall survive the expiration or earlier termination of the Lease.

2. **PREMISES.** LANDLORD leases to COUNTY and COUNTY leases from LANDLORD the Premises as set forth in the Basic Lease Provisions for the duration of the Lease Term, including any extensions thereof. The Parties acknowledge and agree that the Premises shall not be re-measured during the Lease Term nor during any extensions thereof. Along with its lease of the Premises, COUNTY shall have the right to access and use the Allocated Parking at no additional cost or expense to COUNTY for the duration of the Lease Term and any extensions thereof. COUNTY shall further have the right to access and use all common areas meaning those areas located within the Building or on the Property (“Common Areas”) at no additional cost or expense to COUNTY for the duration of the Lease Term and any extensions thereof.

3. **TERM.** The Lease Term shall commence on the Commencement Date and expire on the Expiration Date as set forth in the Basic Lease Provisions unless earlier terminated in accordance with the terms of the Lease. In the event that the Commencement Date is subject to Improvements to be completed by a Projected Occupancy Date, the Parties shall execute a Commencement Date Certificate substantially in the form of Exhibit “C,” attached hereto and incorporated herein by reference, to confirm the occurrence of the actual Commencement Date, the actual Expiration Date, and any other pertinent terms of the Lease. COUNTY shall prepare the Commencement Date Certificate and LANDLORD shall execute and return said certificate within ten (10) days after its receipt from COUNTY. If LANDLORD does not timely execute and return said certificate, LANDLORD shall be deemed to have accepted all of the terms of the Lease as confirmed in the Commencement Date Certificate prepared by COUNTY. COUNTY’s Director of the Real Estate Services Department (“RESD”) shall have the authority on behalf of COUNTY to execute said certificate but only if the occurrence of the actual Commencement Date does not exceed ninety (90) days from the Projected Occupancy Date, subject to Force Majeure as outline in Paragraph 58.

4. **RENT.** COUNTY shall pay to LANDLORD, in arrears on or before the last day of each calendar month during the Lease Term, the Monthly Rent for the Premises in accordance with the rent schedule set forth in the Basic Lease Provisions but subject to any deductions, offsets, and adjustments that are permitted under the Lease. Monthly Rent for the Premises during any partial calendar month during the Lease Term shall be pro-rated based on the actual number of days the Premises is occupied by COUNTY in said month. LANDLORD agrees to accept all Monthly Rent for the Premises and other payments due from COUNTY to LANDLORD under the Lease via electronic payments directly deposited to LANDLORD’s designed bank account. LANDLORD shall complete any and all COUNTY standard forms and provide all information required by COUNTY to process such electronic payments. In addition, on or before the date LANDLORD executes the Lease, LANDLORD shall register with COUNTY’s then current electronic procurement system.

5. **PERMITTED USE.** COUNTY shall have the right to use the Premises for the Permitted Use set forth in the Basic Lease Provisions and shall have reasonable access to the Premises, the Building, and the Property 24 hours a day and seven days a week.

6. **EXPANSION SPACE OPTIONS.**

A. **Right of First Offer for Expansion Space.** Subject to any pre-existing rights granted by LANDLORD, COUNTY shall have the recurring right of first offer during the Lease Term on any available adjacent space to the Premises and any extensions thereof to lease the Expansion Space or any portion thereof

on the same terms and conditions as the Lease, provided that the Lease Term for the subject Expansion Space shall, at the option of COUNTY, be co-terminous with the then current Lease Term for the Premises. If COUNTY opts to exercise its right of first offer, COUNTY shall provide written notice to LANDLORD for the subject Expansion Space and the parties shall thereafter promptly execute an amendment to the Lease to add the subject Expansion Space to the Premises.

7. **OPTION TO EXTEND LEASE TERM.**

A. COUNTY shall have the Option to Extend Lease Term as to the Premises or any portion thereof for the number of option terms ("Option Terms") and the period of time during each option term set forth in the Basic Lease Provisions on the same terms and conditions as the Lease, except the Monthly Rent for the Premises. COUNTY shall not be required to exercise the Option Terms consecutively and COUNTY may opt to exercise one or multiple Option Terms at once. To exercise Option Terms, COUNTY shall provide LANDLORD with minimum 6-months but no more than 12-months, written notice at any time on or prior to the expiration or earlier termination of the then current Lease Term or during any Holdover Period (as later defined).

B. The Monthly Rent for the Premises during each Option Term shall be adjusted by good faith negotiation of the Parties to the fair market monthly rental rate then prevailing based on the monthly rental rent ("FMV Rent") of comparable leased premises in the County of San Bernardino. If the Parties have been unable to agree on the FMV Rent for the Premises within five (5) months of COUNTY's exercise of its option, said FMV Rent shall be determined through arbitration conducted in accordance with the Commercial Arbitration Rules of the American Arbitration Association. During the period between the expiration of the then current Lease Term and the determination of the Monthly Rent for the Premises by arbitration, COUNTY shall continue to pay the Monthly Rent for the Premises in the amount due for the month immediately preceding expiration of the then current Lease Term. If the FMV Rent for the Premises is determined by arbitration and COUNTY does not, for any reason, agree with such determination, COUNTY shall have the right to terminate the Lease by providing LANDLORD with written notice not later than thirty (30) days after COUNTY's receipt of the arbitration-determined FMV Rent. In the event COUNTY does not so terminate the Lease, COUNTY shall commence paying the arbitration-determined FMV Rent for the month immediately following COUNTY's receipt of said rate determination and for the duration of the subject Option Term.

8. **EARLY TERMINATION OPTION.** COUNTY shall have the Early Termination Option as set forth in the Basic Lease Provisions. COUNTY's RESD Director shall have the authority on behalf of COUNTY to provide LANDLORD with notice of any termination pursuant to this paragraph. In the event COUNTY terminates the Lease as to the Premises or any portion thereof pursuant to this paragraph, LANDLORD shall only have the right to receive from COUNTY the Monthly Rent or other sums due which will have been earned under the Lease for the Premises or portion thereof through the effective termination date and for no other amounts.

9. **HOLDOVER.** In the event that COUNTY continues to occupy the Premises after the expiration or earlier termination of the Lease Term, COUNTY's tenancy shall be on a month-to-month term ("Holdover Period") on the same terms and conditions as the Lease, including, but not limited to, the Monthly Rent for the Premises in effect as of the expiration or earlier termination of the Lease. Notwithstanding anything to the contrary in the Lease, either Party shall have the right to terminate the Lease during the Holdover Period by providing not less than ninety (90) days prior written notice to the other Party.

10. **TAXES.** LANDLORD shall, at its sole cost and expense, pay, prior to delinquency, any and all real property taxes and general and special assessments levied and assessed against the Premises, the Building, and the Property and all improvements thereon.

11. **UTILITIES.**

A. Subject to reimbursement by COUNTY for After-Hours HVAC use and any Excess Electric Utility Expenses (as later defined), LANDLORD shall, at its sole cost and expense, furnish and pay for, prior to delinquency, the use charges, and related taxes for any and all utilities, including, but not limited to, electric, gas, water, sewer, and trash for the Premises, the Building, and the Property.

B. HVAC Use and HVAC Electric Utility Expenses.

(1) Routine HVAC for Premises: For the duration of the Lease, including any extensions of the Term, LANDLORD shall, at its sole cost and expense, (i) furnish heating, ventilating and air conditioning ("HVAC") throughout the Premises Monday through Friday from 7:00 a.m. to 6:00 p.m. Pacific, Saturday from 9:00 a.m. to 12:00 p.m. Pacific including all COUNTY holidays and closures ("Routine HVAC Schedule"); (ii) maintain the temperature throughout the Premises at range between a minimum of 68 degrees Fahrenheit and a maximum of 78 degrees Fahrenheit at all times during the Routine HVAC Schedule, and (iii) pay all electric expenses to provide HVAC services pursuant to this Paragraph 11B(1) during the Routine HVAC Schedule.

(2) After-Hours HVAC for Premises:

(a) LANDLORD shall, at its sole cost, furnish heating, ventilating, and air conditioning ("HVAC") to the Premises as stated in Paragraph 11B(1) Routine HVAC Electric Utility for Premises. In the event of any HVAC use at the Premises by COUNTY outside of the times set forth in Paragraph 11(B)(1), upon COUNTY request, LANDLORD shall furnish HVAC services to the Premises during said period and COUNTY shall pay for such after-hours use at the LANDLORD's then current cost without mark-up for after-hours HVAC usage and electric costs, subject to annual increases each lease year based on the increase in LANDLORD's actual electric cost charged by the electric utility provider to provide after-hours HVAC, provided that each lease year increase shall not exceed two and a half percent (2.5%) of the prior year's after-hours rate. As the HVAC is zoned by floor in the Building and is not specific to the Premises, COUNTY shall provide prior notice to LANDLORD in the event after-hours HVAC usage is required and LANDLORD shall ensure that all other tenants or occupants of the floor on which the Premises is located shall similarly provide such notice and otherwise monitor compliance of after-hours HVAC usage. LANDLORD shall maintain accurate records as to any after-hours HVAC usage by floor and pro-rate any such usage based on the square footage of the premises of each tenant using such after-hours HVAC and COUNTY shall have the right to audit such records at COUNTY's costs but if the audit reveals that the amount actually invoiced by LANDLORD for after-hours HVAC costs for the audited period exceeds the amount LANDLORD should have invoiced COUNTY for that period by five percent (5%) or more, then the LANDLORD shall refund the difference to the COUNTY and reimburse the COUNTY for the actual cost of the audit, including any COUNTY staff time. If LANDLORD fails to reimburse the COUNTY, the COUNTY shall have the right to deduct such difference and audit cost from the rents next due under the Lease until fully reimbursed. In the event COUNTY incurs any after-hours HVAC charges, LANDLORD shall provide COUNTY with documentation supporting any after-hours HVAC costs payable by COUNTY along with any invoice for such costs within ninety (90) days after the after-hours charges are incurred, which costs are subject to verification by the COUNTY. If LANDLORD fails to deliver to COUNTY an invoice for after-hours HVAC costs incurred by COUNTY within said ninety (90) days, LANDLORD shall be deemed to have waived its right to collect said after-hours HVAC usage. In addition, any claims by LANDLORD of underpayment with respect a specific invoice for after-hours HVAC cost must be made within one hundred and eighty (180) days after the date of LANDLORD'S invoice for said after-hours usage; otherwise such claims are deemed waived by LANDLORD. The LANDLORD's current after-hours HVAC charge is Sixty-Five Dollars (\$65.00) per hour.

C. Excess Electric Utility Expenses.

(1) Electric Utility Expense. LANDLORD shall pay for all direct charges and related taxes due to COUNTY's electric usage at the Premises ("Electric Utility Expenses"), which are invoiced to LANDLORD by the electric utility company on a monthly basis for each twelve-month period during the Lease Term, commencing from the Commencement Date ("Lease Year"). LANDLORD shall deduct from the Electric Utility Expenses any and all credits, rebates, or other offsets given by the electric utility company to LANDLORD, but LANDLORD shall not increase the Electric Utility Expense due to any late fees, penalties, or interest payable by LANDLORD to the electric utility company. On or before the Commencement Date, the parties shall jointly read the electric meter for the Premises to establish the point at which Electric Utility Expenses for the Premises start to accrue.

(2) Electric Utility Expense Cap. LANDLORD shall pay the Electric Utility Expenses for the Premises up to the Electric Utility Expense Cap. The term "Electric Utility Expense Cap," as used in this paragraph, shall mean the maximum amount payable by LANDLORD for the Electric Utility Expenses for a Lease Year. The Electric Utility Expense Cap for the initial Lease Year, commencing as of the Commencement Date,

shall be forty-seven thousand four hundred four dollars and eighty cents (\$47,404.80), which cap shall increase annually by three percent (3%) at each anniversary of the Commencement Date.

(3) **Excess Electric Utility Expenses.** For each Lease Year where the Electric Utility Expenses for the subject Lease Year exceeds the Electric Utility Expense Cap for the subject Lease Year, COUNTY shall reimburse LANDLORD for such excess costs ("Excess Electric Utility Expenses").

(4) **Reconciliation Statement.** Landlord shall use commercially reasonable efforts to provide a written reconciliation statement within 120 days following the end of each Lease Year or the earlier termination of the Lease, LANDLORD shall provide COUNTY with a written reconciliation statement, along with all supporting invoices and any other documents requested by COUNTY, setting forth the Electric Utility Expenses for the subject Lease Year, the Electric Utility Expense Cap for the subject Lease Year, and any Excess Electric Utility Expenses reimbursable by COUNTY for the subject Lease Year. In the event COUNTY approves said statement, COUNTY shall pay to LANDLORD the Excess Electric Utility Expenses. Failure by LANDLORD to provide a written reconciliation statement for Excess Electric Utility Expenses for any Lease Year or to provide COUNTY with invoices or other supporting documents to verify said excess shall be deemed to be LANDLORD's waiver of any and all Excess Electric Utility Expenses for the subject Lease Year. The provision of this paragraph shall survive the expiration or earlier termination of the Lease.

(5) **Audit Rights.** COUNTY shall have the right to audit LANDLORD's records concerning the Electric Utility Expenses and LANDLORD's calculation of the Excess Electric Utility Expense payable by COUNTY for one or more Lease Years, that is not paid on a contingency basis. If an audit demonstrates that a discrepancy of five percent (5%) or more between the Excess Electric Utility Expenses paid by COUNTY for the subject Lease Year(s) and the Excess Electric Utility Expense that should have been paid by COUNTY as demonstrated by the audit for the subject Lease Year(s), at COUNTY's option, LANDLORD shall reimburse COUNTY for such discrepancy and pay for the actual cost of said audit (including but not limited to the value of COUNTY's employee and staff time and equipment used) but which amount shall not exceed \$3,000, or COUNTY shall have the right to deduct such amount of said discrepancy and the actual cost of the audit (including but, not limited to, the value of COUNTY's employee and staff time and any equipment used) but not to exceed a total of \$3,000 against the Monthly Rent payable for the Premises until such time that the amounts due to COUNTY have been fully reimbursed.

C. **Interruptions.** In the event of any interruption of any utilities provided to the Premises, the Building, or the Property and COUNTY determines, in its sole discretion, that COUNTY is unable access the Premises or the Allocated Parking or unable to conduct its operations at the Premises as a result of such interruption, LANDLORD shall immediately restore the affected utility service(s) and Monthly Rent shall be abated for the duration of the interruption in proportion to the Premises or portion thereof that is inaccessible or unusable by COUNTY to conduct its operation and COUNTY shall have the right to deduct the abated amount from the Monthly Rent and other sums next due for the period from the date the interruption commenced until such time that the affected utility is fully restored.

12. **LEGAL COMPLIANCE.**

A. **Compliance with Laws.** As a condition precedent to COUNTY's obligations under the Lease, (i) the Premises, the Building, and the Property comply with the applicable requirements of all municipal, county, state, federal, and regulatory laws, statutes, codes, ordinances, and regulations for public and government buildings then in effect, including, but not limited to, applicable Health, Safety, Fire and Building codes, notice of completion, certificate of occupancy, California Title 24, and the Americans with Disabilities Act ("ADA") collectively, ("Laws"); (ii) an accessible path of travel exists from public transportation to the Premises pursuant to California Title 24 requirements; (iii) all improvements in or on the Premises, the Building, and the Property (whether constructed by LANDLORD, prior tenants, or any third party) comply with all applicable covenants or restrictions of record for the Property and all applicable Laws; (iv) LANDLORD has not received any violations of Laws from any relevant government authority with respect to the Premises, the Building, or the Property; and (v) LANDLORD has no knowledge of any pending or threatened claims of any violations of Laws from any third party with respect to the Premises, the Building, or the Property. LANDLORD covenants that LANDLORD shall, at its sole cost and expense, maintain the Premises, the Building, and the Property in compliance with all

applicable Laws for the duration of the Lease Term and any extensions thereof. LANDLORD represents and warrants to COUNTY that the forgoing is true and accurate as of the Commencement Date. In the event of a breach of the foregoing representations, warranties, or covenants herein, LANDLORD shall, at its cost and sole expense, promptly remedy any non-compliance with Laws and indemnify, defend (with counsel reasonably approved by COUNTY), and hold harmless COUNTY and its officers, employees, agents, and volunteers from any and all claims, actions, losses, damages and/or liability arising out of or related to said breach. LANDLORD's indemnity obligation shall survive the expiration or earlier termination of the Lease. In the event of that the Premises, the Building or the Property requires modifications due to changes in Laws during the Lease Term or any extensions thereof, LANDLORD shall, at its sole cost and expense, promptly complete such modification.

B. CASp Inspection. LANDLORD certifies to COUNTY that as of the Commencement Date, an inspection of the Premises, the Building, or the Property has not been performed by a Certified Access Specialist in conjunction with the Lease. Notwithstanding that an access inspection has not been performed, LANDLORD remains obligated for the compliance of the Premises, the Building, and the Property with Laws for the duration of the Lease Term including any extensions thereof. In the event that an access inspection is performed by LANDLORD at any time during the Lease Term including any extensions thereof, LANDLORD shall provide COUNTY with a copy of the inspection report and LANDLORD shall, at its sole cost and expense, promptly complete all required and recommended repairs and modifications to the Premises, the Building, or the Property identified in the inspection report.

13. HAZARDOUS SUBSTANCES.

A. LANDLORD hereby represents and warrants to COUNTY that, as of the Commencement Date: (i) the Premises, the Building, and the Property have not been exposed to Hazardous Substances and are free of all Hazardous Substances; (ii) neither LANDLORD nor any existing or former tenants or occupants at the Property were or are in violation of or subject to an existing, pending or threatened investigation by any governmental authority under any applicable local, state, and federal law, regulation, ordinance or other legislation pertaining to air, water, or soil quality or the handling, transportation, storage, treatment, usage or disposal of Hazardous Substances; (iii) any handling, transportation, storage, treatment, usage, or disposal of Hazardous Substances at the Premises, the Building, and the Property has been or are in compliance with applicable laws; and (iv) no reportable use has occurred on the Premises, the Building, and the Property and the vapor, groundwater and soil on or under the Premises, the Building, and the Property is free of Hazardous Substances.

B. LANDLORD shall indemnify, defend (with counsel reasonably approved by COUNTY), protect, and hold harmless COUNTY and its officers, employees, agents, and volunteers and the Premises, from any and all claims, actions, losses, damages, judgments, costs, expenses, penalties, and/or liability, including, but not limited to, attorneys' and consultant's fees, arising out of or related to the existence of any Hazardous Substances located in, on, under, or about the Premises, the Building, and the Property occurring: (i) prior to the Commencement Date and (ii) during the Lease Term to the extent not directly and solely caused by COUNTY. Additionally, the issuance of an order by any governmental authority directing LANDLORD or any of LANDLORD's other tenants or occupants on the Property to cease and desist any illegal action in connection with a Hazardous Substance, or to remediate a contaminated condition caused by LANDLORD or any person acting under LANDLORD's direct control and authority is a default of the Lease, and LANDLORD shall be responsible for all costs and expenses of complying with such order, including any and all expenses imposed on or incurred by COUNTY in connection with or in response to such order. LANDLORD's obligations under this paragraph shall include, but shall not be limited to, the effects of any contamination or injury to person, property or the environment created or suffered by COUNTY, and the cost of investigation, removal, remediation, restoration and/or abatement thereof. LANDLORD's obligations under this provision shall survive the expiration or early termination of the Lease. No termination, cancellation or release agreement entered into by COUNTY and LANDLORD shall release LANDLORD from its obligations under the Lease with regard to Hazardous Substances unless specifically agreed to by COUNTY in writing. LANDLORD's indemnity obligation shall survive the expiration or earlier termination of the Lease.

C. For the purposes of this paragraph, the following definitions shall apply:

(1) "Hazardous Substance," as used in the Lease, shall mean any product, substance, material, or waste whose presence, use, manufacture, disposal, transportation, or release, either by itself or in combination with other materials expected to be on the Premises, is either: (a) potentially injurious to the public health, safety or welfare, the environment or the Premises, the Building, or the Property; (b) regulated or monitored by any governmental authority; or (c) a basis for potential liability of LANDLORD or COUNTY under any applicable statute or common law theory.

(2) "Reportable use" shall mean: (a) the installation or use of any above- or below-ground storage tank; (b) the generation, possession, storage, use, transportation or disposal of a Hazardous Substance that requires a permit from, or with respect to which a report, notice, registration or business plan is required to be filed with any governmental authority and/or (c) the presence at the Premises, the Building, or the Property of a Hazardous Substance with respect to which any Applicable Requirements requires that a notice be given to persons entering or occupying the Premises, the Building, the Property or neighboring properties.

(3) The term "applicable requirements" shall be deemed to refer to all applicable laws, covenants or restrictions of record, building codes, regulations and ordinances.

14. **ALTERATIONS.** COUNTY shall not make any structural or exterior improvement or alterations to the Premises during the Lease Term without LANDLORD's prior written consent. If LANDLORD does not respond within thirty (30) days after COUNTY's request for consent for any structural or exterior improvements or alterations, LANDLORD shall be deemed to have approved COUNTY's request. Upon the expiration or earlier termination of the Lease, such improvements or alterations shall be surrendered along with the Premises and COUNTY shall have no removal or restoration obligation.

15. **FIXTURES.** COUNTY shall have the right to install shelving and fixtures and make interior, non-structural improvements or alterations in the Premises during the Lease Term without LANDLORD's prior consent. Such shelving, fixtures, improvements, and alterations shall remain the property of COUNTY during the Lease Term, and may, at COUNTY's option, in its sole discretion, either: (i) be removed during the Lease Term or upon the expiration or earlier termination of the Lease or within a reasonable time thereafter without the payment of Monthly Rent or other sums, provided that COUNTY restores any damage caused by such removal; or (ii) be surrendered along with the Premises, in which case, COUNTY shall have no removal or restoration obligation. COUNTY shall have the right, at its options, to install at the Premises, telephone and data cabling, a security system, and vending machines.

16. **SIGNS.** COUNTY shall at no additional cost to COUNTY, have the right to install any signage, including, but not limited to: (i) in the interior of the Premises, including those that may visible from outside the Premises; (ii) at or near the entry to the Premises, including those that may be located outside of the Premises but inside the Building; (iii) in the Building directory and in the Building lobby; and (iv) on the exterior of the Building or the Property, provided that such exterior signage complies with applicable laws and is approved by LANDLORD. If LANDLORD does not respond within ten (10) days after COUNTY's request for consent for exterior signage, LANDLORD shall be deemed to have approved COUNTY's request.

17. **MAINTENANCE AND REPAIR.**

A. LANDLORD represents and warrants to COUNTY that as of the Commencement Date, the Premises, the Building, and the Property, including but not limited to all structural elements, the building systems, and other improvements thereon are in good working order, condition, and repair and water tight. During the Lease Term, including any extensions thereof, LANDLORD shall, at its sole cost and expense, provide the following services and perform all inspections, maintenance, repairs, and replacements as is necessary or as reasonably requested by COUNTY to keep in good working order, condition, and repair and water-tight, all structural elements, the building systems, and other improvements thereon, including but not limited to the following:

(1) All structural and other elements of the Premises, Building, and the Property, inclusive of all components thereto and regardless of where situated on the Property, including, but not limited to, the roof; foundation; slab; sub-flooring; façade; exterior and load-bearing walls; eaves, gutters, and downspouts; exterior windows, frames, and glass; exterior doors; lobbies, elevators, and stairs and stairwells; in the event of water intrusion, LANDLORD shall repair any such intrusions and remediate any and all mold or other contaminants and perform all recommended repairs in a report provided by its third-party contractors; and,

(2) All systems of the Premises, the Building, and the Property inclusive of all components thereto and regardless of where situated on the Property, including, but not limited to, all mechanical, electrical, lighting, plumbing, water, and sewage and electric generators; plumbing maintenance shall include, but is not limited to, unclogging and repairing all drains, pipes, toilets, sinks, and other restroom fixtures and repairing water intrusion issues and remediation of mold and other contaminants regardless of cause; lighting maintenance shall include, but is not limited to, bulb and ballast replacements; and

(3) All heating, ventilation and air conditioning (“HVAC”) systems of the Premises, the Building, and the Property, inclusive of all components thereto and regardless of where situated on the Property; HVAC maintenance shall include, but is not limited to, providing certified air balance and maintenance service (with a copy of the certificate to be delivered to COUNTY on the Commencement Date and on each second anniversary of the Commencement Date during the Lease Term) and replacing all filters on a quarterly basis; and

(4) All life-safety systems of the Premises, Building, and the Property, inclusive of all components thereto and regardless of where situated on the Property, including, but not limited to, fire suppression; fire sprinklers; fire alarms; fire extinguishers; and exit signage; and

(5) All grounds of the Property, inclusive of all components thereto, including, but not limited to, parking lot, parking structures, accessible parking spaces, drive lanes, and driveways; sidewalks; fences and gates; exterior lighting; exterior signage; and landscaping; parking maintenance shall include, but is not limited to cleaning, repaving, re-striping, curb and pothole repairs, and replacements; landscaping maintenance shall include, but is not limited to grass, trees, shrubbery, and flora, which shall be kept in a green condition; and

(6) Interior non-structural elements of the Premises, the Building, and the Property, inclusive of all components thereto and regardless of where situated on the Property, including, but not limited to, walls and ceilings; windows, frames, and glass; doors; fixtures, restrooms, break rooms, drinking fountains, and hallways, including, but not limited to, due to vandalism;

(7) Custodial, janitorial, and pest control services for the Premises (in accordance with Exhibit “D”, attached hereto and incorporated herein by reference), the Building, and the Property; including, but not limited to, due to vandalism; and

(8) At any time after the seventh anniversary of the Commencement Date, at COUNTY’s election, in its sole discretion, LANDLORD shall either: (i) replace, at LANDLORD’s sole cost and expense, the carpet throughout the entire Premises, meeting the same criteria as specified in Exhibit “B-2”, Improvement Specifications, within thirty days after COUNTY’s election; or (ii) provide COUNTY with credit against the Monthly Rent (“Rent Credit”) in the amount determined in accordance with this paragraph. In the event COUNTY opts to receive Rent Credit, LANDLORD shall, within thirty (30) days after COUNTY’S election, obtain three (3) competitive bids from licensed and bonded local carpet vendors approved by COUNTY and the amount of the Rent Credit shall be the amount of the lowest of the competitive bids received, which credit will be applied toward Monthly Rent next due to LANDLORD and each Monthly Rent due thereafter until such credit is exhausted. If LANDLORD fails to obtain said competitive bids with the timeframe stated in this paragraph, COUNTY shall have the right to obtain such bids, present said bids to LANDLORD to substantiate the total Rent Credit due to COUNTY and apply such credit toward the Monthly Rent next due to LANDLORD and each Monthly Rent due thereafter until such credit is exhausted. COUNTY shall have the recurring right to elect the replacement of the carpet throughout the entire Premises or Rent Credit pursuant to this paragraph during the Lease Term, provided that at least seven years has elapsed since the date of COUNTY’s immediately preceding election.

(9) At any time on or after the fifth anniversary of the Commencement Date, at COUNTY's election, in its sole discretion, LANDLORD shall either: (i) repaint, at LANDLORD's sole cost, the entire interior of the Premises, meeting the same criteria as specified in Exhibit "B-2", Improvement Specifications, within thirty days after COUNTY's election; or (ii) provide COUNTY with Rent Credit in the amount determined in accordance with this paragraph. In the event COUNTY opts to receive Rent Credit, LANDLORD shall, within thirty (30) days after COUNTY'S election, obtain three (3) competitive bids from licensed and bonded local paint vendors approved by COUNTY and the amount of the Rent Credit shall be the amount of the lowest of the competitive bids received, which credit will be applied toward Monthly Rent next due to LANDLORD and each Monthly Rent due thereafter until such credit is exhausted. If LANDLORD fails to obtain said competitive bids with the timeframe stated in this paragraph, COUNTY shall have the right to obtain such bids, present said bids to LANDLORD to substantiate the total Rent Credit due to COUNTY and apply such credit toward the Monthly Rent next due to LANDLORD and each Monthly Rent due thereafter until such credit is exhausted. COUNTY shall have the recurring right to elect repainting of the entire interior of the Premises or Rent Credit pursuant to this paragraph during the Lease Term, provided that at least five years has elapsed since the date of COUNTY's immediately preceding election.

B. LANDLORD shall engage licensed and bonded contractors to perform LANDLORD's maintenance and custodial obligations in the Lease, which services shall be performed in a good and workmanlike manner. With respect to the Premises, LANDLORD's maintenance and custodial obligations shall be performed at times during COUNTY's regular business hours that are approved in writing by COUNTY. LANDLORD's service providers must be escorted by COUNTY staff while in the Premises and such services shall be performed in a manner that will cause the least possible inconvenience, annoyance, or disturbance to COUNTY.

C. Without in any way affecting LANDLORD'S obligations in this paragraph and regardless of whether any specific notice of need for maintenance or repair is provided to LANDLORD by COUNTY, COUNTY may request specific maintenance. Any such request may be made orally, by telephone, or otherwise. If: (i) COUNTY requests maintenance and LANDLORD does not commence the performance of its maintenance obligations within ten (10) days of receiving such request or does not diligently prosecute its obligations to completion thereafter; or (ii) in the case of an emergency, whether or not COUNTY has given notice to LANDLORD, LANDLORD does not immediately perform its obligations, then in both instances, COUNTY may (but is not obligated to) perform LANDLORD'S obligations, in which case, LANDLORD shall reimburse COUNTY the sum actually expended by COUNTY (including but not limited to charges for COUNTY employees and equipment) in the performance of LANDLORD's obligations. The sum expended by COUNTY shall be due from LANDLORD to COUNTY within five (5) days of notice of COUNTY's invoice to LANDLORD along with documentation supporting the expended costs, and if paid at a later date, shall bear interest at the maximum rate COUNTY is permitted by law to charge from the date the sum was paid by COUNTY until COUNTY is reimbursed by LANDLORD. If LANDLORD fails to reimburse COUNTY as required by this paragraph, COUNTY shall have the right to deduct from future Monthly Rent or other sums due the amount COUNTY has paid until COUNTY is reimbursed in full for the sum and interest thereon. The remedies set forth in this paragraph are in addition to and do not in any manner limit other remedies set forth in the Lease.

D. In the event of any that any maintenance, repair, or replacement by LANDLORD causes, as determined by COUNTY in its sole discretion, the Premises or the Allocated Parking to be inaccessible or the Premises or any portion thereof to be unusable for COUNTY to conduct its operations, Monthly Rent and other sums due under the Lease shall be abated for the commencement of the need for maintenance, repair, or replacement until such time that said maintenance, repair, or replacement is fully completed in proportion to the Premises or portion thereof that is inaccessible or unusable by COUNTY.

E. At COUNTY's election, in its sole discretion, LANDLORD, shall, at LANDLORD's sole cost and expense, hire a licensed, bonded, and qualified property management company to manage the Property and perform LANDLORD'S maintenance and custodial obligations as set forth in the Lease. Within fourteen (14) days after the engagement of a property management company, the property manager of the property management company shall inspect the Premises, the Building, and the Property at least every other week to ensure compliance with LANDLORD'S maintenance obligations and daily to ensure compliance with

LANDLORD'S custodial obligations. COUNTY reserves the right to review the selection of the property management company and to review the engagement agreement.

18. **ASSIGNMENT AND SUBLEASE.** COUNTY shall have the right to assign the Lease or sublease the Premises or any portion thereof with LANDLORD's prior written consent, which consent shall not be unreasonably withheld, delayed, or conditioned. Notwithstanding anything to the contrary in the Lease, at any time during the Lease Term, COUNTY shall have the right, without LANDLORD's consent, to assign the Lease, sublease the Premises or any portion thereof, or share occupancy of the Premises or any portion thereof with any entity under common control with COUNTY, special districts of the COUNTY, and joint powers associations of which the COUNTY is a member; in which event, LANDLORD shall not have the right to share in any rents that exceed the Monthly Rent or to recapture the Premises or any portion thereof.

19. **INDEMNIFICATION.** LANDLORD agrees to indemnify, defend (with counsel reasonably approved by COUNTY) and hold harmless COUNTY and its officers, employees, agents and volunteers from any and all claims, actions, losses, damages, and/or liability arising out of (a) any claim that the Improvements constructed by LANDLORD are defective, (b) LANDLORD's acts and omissions in connection with its ownership of the Building, or (c) any claims of LANDLORD's negligence in the Common Areas.. The provision of the Lease shall survive the expiration or earlier termination of the Lease.

20. **INSURANCE REQUIREMENTS AND SPECIFICATIONS.**

A. COUNTY is a self-insured public entity for purposes of general liability and workers' compensation.

B. LANDLORD agrees to provide insurance set forth in accordance with the requirements herein. If LANDLORD uses existing coverage to comply with these requirements and that coverage does not meet the specified requirements, LANDLORD agrees to amend, supplement or endorse the existing coverage to do so. The type(s) of insurance required is determined by the scope of the Lease.

Without in anyway affecting the indemnity herein provided and in addition thereto, LANDLORD shall secure and maintain throughout the Lease Term the following types of insurance with limits as shown:

(1) **Workers' Compensation/Employers Liability** – A program of Workers' Compensation insurance or a state-approved, self-insurance program in an amount and form to meet all applicable requirements of the Labor Code of the State of California, including Employer's Liability with \$250,000 limits covering all persons including volunteers providing services on behalf of LANDLORD and all risks to such persons under the Lease.

If LANDLORD has no employees, it may certify or warrant to COUNTY that it does not currently have any employees or individuals who are defined as "employees" under the Labor Code and the requirement for Workers' Compensation coverage will be waived by COUNTY's Director of Risk Management.

If LANDLORD is a non-profit corporation, organized under California or Federal law, volunteers for LANDLORD are required to be covered by Workers' Compensation insurance.

(2) **Commercial/General Liability Insurance** – LANDLORD shall carry General Liability Insurance covering all operations performed by or on behalf of LANDLORD providing coverage for bodily injury and property damage with a combined single limit of not less than one million dollars (\$1,000,000), per occurrence. The policy coverage shall include:

- (a) Premises operations and mobile equipment.
- (b) Products and completed operations.
- (c) Broad form property damage (including completed operations).
- (d) Explosion, collapse and underground hazards.
- (e) Personal injury
- (f) Contractual liability.

(g) \$2,000,000 general aggregate limit.

(3) Commercial Property Insurance providing all risk coverage for the Premises, Building, fixtures, equipment and all property constituting a part of the Premises. Coverage shall be sufficient to insure One Hundred percent (100%) of the replacement cost.

(4) Automobile Liability Insurance – Primary insurance coverage shall be written on ISO Business Auto coverage form for all owned, hired and non-owned automobiles or symbol 1 (any auto). The policy shall have a combined single limit of not less than one million dollars (\$1,000,000) for bodily injury and property damage, per occurrence.

If LANDLORD is transporting one or more non-employee passengers in relation to the Lease, the automobile liability policy shall have a combined single limit of two million dollars (\$2,000,000) for bodily injury and property damage per occurrence.

If LANDLORD owns no autos, a non-owned auto endorsement to the General Liability policy described above is acceptable.

(5) Umbrella Liability Insurance - An umbrella (over primary) or excess policy may be used to comply with limits or other primary coverage requirements. When used, the umbrella policy shall apply to bodily injury/property damage, personal injury/advertising injury and shall include a “dropdown” provision providing primary coverage for any liability not covered by the primary policy. The coverage shall also apply to automobile liability.

C. If LANDLORD performs any construction of the Premises on behalf of COUNTY, LANDLORD shall also procure and maintain coverages as follows:

(1) For construction contracts for projects over One Million Dollars (\$1,000,000) and less than Three Million Dollars (\$3,000,000) require limits of not less than Three Million Dollars in General Liability and Auto Liability coverage.

(2) For construction contracts for projects over Three Million Dollars (\$3,000,000) and less than Five Million Dollars (\$5,000,000) require limits of not less than Five Million Dollars (\$5,000,000) in General Liability and Auto Liability coverage.

(3) For construction contracts for projects over Five Million Dollars (\$5,000,000) and less than Ten Million Dollars (\$10,000,000) require limits of not less than Ten Million Dollars (\$10,000,000) in General Liability and Auto Liability coverage.

(4) LANDLORD agrees to require all parties, subcontractors, or others, including, but not limited to, architects, it hires or contracts within relation to the Lease to provide insurance covering the contracted operations with the requirements in this Paragraph 20, (including, but not limited to, waiver of subrogation rights) and naming COUNTY as an additional insured. LANDLORD agrees to monitor and review all such coverage and assumes all responsibility ensuring that such coverage is provided as required here.

(5) Course of Construction/Installation (Builder’s Risk) property insurance providing all risk, including theft coverage for all property and materials to be used on the project. The insurance policy shall not have any coinsurance penalty.

D. Additional Insured – All policies, except for the Workers’ Compensation, shall contain endorsements naming COUNTY and its officers, employees, agents and volunteers as additional insureds with respect to liabilities arising out of the Lease. The additional insured endorsements shall not limit the scope of coverage for COUNTY to vicarious liability but shall allow coverage for COUNTY to the full extent provided by the policy. Such additional insured coverage shall be at least as broad as Additional Insured (Form B) endorsement form ISO, CG 2010.11 85.

E. Waiver of Subrogation Rights – LANDLORD shall require the carriers of required coverages to waive all rights of subrogation against COUNTY, its officers, employees, agents, volunteers, contractors and subcontractors. All general or auto liability insurance coverage provided shall not prohibit LANDLORD and LANDLORD's employees or agents from waiving the right of subrogation prior to a loss or claim. LANDLORD hereby waives all rights of subrogation against COUNTY.

F. Policies Primary and Non-Contributory – All policies required herein are to be primary and non-contributory with any insurance or self-insurance programs carried or administered by COUNTY.

G. Severability of Interests – LANDLORD agrees to ensure that coverage provided to meet these requirements is applicable separately to each insured and there will be no cross-liability exclusions that preclude coverage for suits between LANDLORD and COUNTY or between COUNTY and any other insured or additional insured under the policy.

H. Proof of Coverage – LANDLORD shall furnish Certificates of Insurance to COUNTY's RESD administering the Lease evidencing the insurance coverage at the time the Lease is executed, additional endorsements, as required, shall be provided prior to the commencement of performance of services hereunder, which certificates shall provide that such insurance shall not be terminated or expire without thirty (30) days written notice to COUNTY RESD, and LANDLORD shall maintain such insurance from the time the Lease is executed until the expiration or earlier termination of the Lease. Within fifteen (15) days of the Commencement Date, LANDLORD shall furnish a copy of the declaration page for all applicable policies and will provide complete certified copies of the policies and endorsements immediately upon request.

I. Acceptability of Insurance Carrier – Unless otherwise approved by COUNTY's Director of Risk Management, insurance shall be written by insurers authorized to do business in the State of California and with a minimum "Best" Insurance Guide rating of "A- VII".

J. Deductibles and Self-Insured Retention - Any and all deductibles or self-insured retentions in excess of \$10,000 shall be declared to and approved by COUNTY's Director of Risk Management.

K. Failure to Procure Coverage – All insurance required must be maintained in force at all times by LANDLORD. In the event that any policy of insurance required under the Lease does not comply with the requirements, is not procured, or is canceled and not replaced, COUNTY has the right but not the obligation or duty to cancel the Lease or obtain insurance if it deems necessary and any premiums paid by COUNTY will be promptly reimbursed by LANDLORD or COUNTY payments to LANDLORD will be reduced to pay for COUNTY purchased insurance.

L. Insurance Review – Insurance requirements are subject to periodic review by COUNTY. COUNTY's Director of Risk Management or designee is authorized, but not required, to reduce, waive or suspend any insurance requirements whenever COUNTY's Director of Risk Management determines that any of the required insurance is not available, is unreasonably priced, or is not needed to protect the interests of COUNTY. In addition, if COUNTY's Director of Risk Management determines that heretofore unreasonably priced or unavailable types of insurance coverage or coverage limits become reasonably priced or available, COUNTY's Director of Risk Management or designee is authorized, but not required, to change the above insurance requirements to require additional types of insurance coverage or higher coverage limits, provided that any such change is reasonable in light of past claims against COUNTY, inflation, or any other item reasonably related to COUNTY's risk.

Any change requiring additional types of insurance coverage or higher coverage limits must be made by amendment to the Lease. LANDLORD agrees to execute any such amendment within thirty (30) days of receipt.

Any failure, actual or alleged, on the part of COUNTY RESD or COUNTY to monitor or enforce compliance with any of the insurance and indemnification requirements will not be deemed as a waiver of any rights on the part of COUNTY RESD or COUNTY.

M. COUNTY shall have no liability for any premiums charged for such coverage(s). The inclusion of COUNTY as additional named insured is not intended to and shall not make a partner or joint venturer with LANDLORD in LANDLORD's operations.

N. LANDLORD agrees to require all parties, subcontractors, or others it hires or contracts within relation to the Lease to provide insurance covering the contracted operation with the requirements in this Paragraph 20, (including, but not limited to, waiver of subrogation rights) and naming COUNTY as an additional insured.

21. **DESTRUCTION OF PREMISES.**

A. In the event the Premises, the Allocated Parking, the Building, the Property, or COUNTY's access thereto, or any portion thereof, is damaged or destroyed by any casualty, LANDLORD shall, at its sole cost and expense, promptly repair and restore the Premises, the Allocated Parking, the Building, the Property or COUNTY's access thereto to substantially the same condition as existing immediately prior to the damage or destruction, including, but not limited to: (i) all mechanical, electrical, and plumbing systems serving the Premises, the Building, and the Property; (ii) the heating, ventilation, and air conditioning systems serving the Premises and the Building; (iii) the roof, foundation, and all interior and exterior windows and walls of the Premises and the Building; and (iv) all Improvements constructed in the Premises (whether by LANDLORD or COUNTY) prior to the date of damage or destruction and the Lease shall continue in full force and effect. LANDLORD shall use any and all insurance proceeds received as a result of such casualty for the repair and restoration of the Premises, provided that LANDLORD's failure to carry any required insurances shall not relieve LANDLORD of its repair and restoration obligation. Notwithstanding the foregoing, Landlord shall have no obligation to repair any damage to, or to replace any of COUNTY's personal property, furnishings, fixtures, and equipment, unless such damage is caused by LANDLORD's gross negligence or intentional misconduct. LANDLORD shall commence the required repair and restoration in a substantial and meaningful way within sixty (60) days of the date of damage or destruction and shall thereafter diligently pursue such repair and restoration to completion within a reasonable time period considering the extent of the damage as of the commencement of said repair and restoration. For the purposes of this paragraph, the phrase "commence . . . in a substantial and meaningful way" shall mean the unconditional authorization to prepare the plans required for repair and restoration work, the issuance of any required building permits from the relevant governmental authority, or the beginning of actual repair or restoration work. In the event that within thirty (30) days after the casualty date, COUNTY is notified by LANDLORD that the time required to restore the Premises, the Allocated Parking, the Building, the Property, or COUNTY's access thereto, or any portion thereof, is estimated by LANDLORD's licensed and qualified architect, in its professional opinion, to exceed One Hundred Twenty (120) days, COUNTY may, at its option, terminate this Lease immediately upon written notice to the LANDLORD without further obligation by COUNTY.

B. In the event: (i) the Premises, the Allocated Parking, the Building, the Property, or COUNTY's access thereto, is substantially damaged or destroyed so that COUNTY reasonably determines it cannot operate its operations in the Premises due to such damage or destruction; and (ii) LANDLORD fails to timely commence and complete the repair and restoration required in Paragraph 21.A above; and COUNTY shall have the right, at its option, to terminate the Lease effective as of the date the damage or destruction occurred.

C. In the event the Premises, the Allocated Parking, the Building, the Property, or COUNTY's access thereto is substantially damaged or destroyed by any casualty and COUNTY reasonably determines, in its sole discretion, that COUNTY is unable to conduct its operations at the Premises as a result of such damage or destruction, the Monthly Rent and any other sums due under the Lease shall be abated in whole or in proportion to the Premises, Allocated Parking, or access thereto that are not usable by COUNTY to conduct its business, which abatement shall commence on the date the damage or destruction occurred and shall continue until the date the such damage or destruction is fully restored. In the event undamaged space is available in the Building, LANDLORD shall provide COUNTY with temporary space during the restoration period at no cost to COUNTY.

22. **CONDEMNATION.**

A. Notice. In the event the Property or any portion thereof is taken under the power of eminent domain by a condemning authority or voluntarily transferred to such authority under the threat of the exercise of said power ("Condemnation"), within five (5) days of its receipt of a notice of Condemnation from a condemning authority ("Condemnation Notice"), LANDLORD shall provide COUNTY with a copy of said notice.

B. Total. In the event the entirety of Premises, the Allocated Parking, the Building the Property, or COUNTY's access thereto, is taken by Condemnation, the Lease shall terminate as of the date the condemning authority takes title or possession, whichever first occurs.

C. Partial. In the event that any substantial portion of the Premises, the Allocated Parking, the Building, the Property, or COUNTY's access thereto, is taken by Condemnation and COUNTY determines, in its sole but reasonable discretion, that COUNTY is unable to conduct its operations at the Premises as a result of such partial taking, COUNTY shall have right based on the foregoing determination, at its option, to terminate the Lease by providing LANDLORD with notice to be given within thirty (30) days after COUNTY's receipt of the Condemnation Notice from LANDLORD, or if LANDLORD fails to provide COUNTY with a Condemnation Notice, within thirty (30) days after the date the condemning authority takes possession. If COUNTY does not exercise its right to terminate the Lease as provided herein, within 60-days of LANDLORD's issuance of such notice, the Lease shall continue in full force and effect, except that if a portion of the Premises was taken, the Premises shall be reduced by the portion taken and the Monthly Rent and any other sums due under the Lease shall be reduced in the same proportion as the floor area of the Premises taken bears to the original floor area of the Premises and if the Allocated Parking, COUNTY's access, or other portions of the Property affecting COUNTY's use of the Premises was partially taken, the Monthly Rent and other sums due shall be equitably adjusted with the mutual agreement of LANDLORD and COUNTY. In addition, LANDLORD shall within thirty (30) days make all repairs or alterations to the Premises, Building, and Property required as a result of the Condemnation to restore the remaining portions thereof to substantially the same conditions as existing immediately prior to the Condemnation and in accordance with the provisions of the Lease.

D. Awards. COUNTY shall be entitled to receive the following amounts of any award for the taking of the Premises or any portion thereof under Condemnation, whether from LANDLORD or by separate claim to the condemning authority, with COUNTY having the right to negotiate directly with the condemning authority for such award,: (i) fifty percent (50%) of any amount attributable to any excess of the market value of the Premises for the remainder of the Lease Term over the present value as of the date the Lease is terminated of the Monthly Rent payable for the remainder of the Lease Term (commonly referred to as the "bonus value" of the Lease); (ii) the amortized or undepreciated value of any Improvements and trade fixtures owned by COUNTY and the removal and relocation costs of such Improvements and trade fixtures; (iii) relocation costs; (iv) loss of goodwill, and (v) any other permitted under condemnation law.

23. **LANDLORD'S DEFAULT.** Except where another time period is specifically provided, LANDLORD shall be in default of the Lease if LANDLORD fails or refuses to perform any material provisions of the Lease and such failure or refusal to perform is not cured within thirty (30) days following LANDLORD's receipt of written notice of default from COUNTY; provided however, if the nature of the default or material provision of the Lease is such that it cannot reasonably be cured within thirty (30) days, LANDLORD shall not be in default of the Lease if LANDLORD commences to cure the default within the thirty (30) day period and thereafter diligently and in good faith prosecutes such cure to completion.

24. **COUNTY'S REMEDIES ON LANDLORD'S DEFAULT.** COUNTY may, at any time after LANDLORD is in default beyond any applicable notice and cure period, at its option and in its sole discretion, after 30-day notice to LANDLORD cure LANDLORD's default. If COUNTY elects to cure LANDLORD's default, LANDLORD shall reimburse COUNTY the sum actually expended by COUNTY (including but not limited to charges for COUNTY employees and equipment) in curing LANDLORD's default. The sum expended by COUNTY shall be due from LANDLORD to COUNTY within fifteen (15) days of notice of COUNTY's invoice to LANDLORD along with documentation supporting the expended costs, and if paid at a later date, shall bear interest at ten percent (10%) per annum from the date the sum was paid by COUNTY until COUNTY is reimbursed by LANDLORD. If LANDLORD fails to reimburse COUNTY as required by this paragraph, COUNTY shall have the right to withhold from future Monthly Rent and other sums due the amount COUNTY has paid until COUNTY is reimbursed in full

for the sum and interest on it. The remedies set forth in this paragraph are in addition to and do not in any manner limit other remedies set forth in the Lease.

25. **COUNTY'S DEFAULT.** The occurrence of any one or more of the following events shall constitute a material default of the Lease by COUNTY: (i) vacating or abandoning the Premises for more than thirty (30) consecutive days while Monthly Rent is concurrently in arrears; or (ii) failure by COUNTY to perform any material provisions of the Lease to be performed by COUNTY, including the payment of Monthly Rent, where such failure is not cured within thirty (30) days following COUNTY's receipt of written notice of default from LANDLORD; provided, however, if the nature of the default is such that it cannot reasonably be cured within thirty (30) days, COUNTY shall not be in default of the Lease if COUNTY commences to cure the default within the thirty (30) day period and thereafter diligently and in good faith prosecutes such cure to completion. The purpose of this notice requirement is to extend the notice requirements of the unlawful detainer statutes of California.

26. **LANDLORD'S REMEDIES ON COUNTY'S DEFAULT.** LANDLORD may, at any time after COUNTY is in default beyond any applicable notice and cure period, exercise any and all remedies available pursuant to law or granted pursuant to the Lease; provided, however, that notwithstanding anything herein to the contrary, there shall be no right under any circumstances to accelerate the Monthly Rent or other sums due or otherwise declare any Monthly Rent or other sums due to be immediately payable. Each and every covenant hereof to be kept and performed by COUNTY is expressly made a condition and upon the default thereof LANDLORD may, at its option, terminate the Lease, provided that LANDLORD shall use reasonable efforts to mitigate its damages. In the event of such default beyond any applicable notice and cure period, COUNTY shall continue to remain liable for the payment of the Monthly Rent, other sums due, and/or damages for default of the Lease; in which case, such Monthly Rent, other sums, and/or damages shall be payable to LANDLORD only at the same time and in the same manner as provided for the payment of Monthly Rent.

27. **LANDLORD'S ENTRY TO PREMISES.** Upon not less than twenty-four (24) hours prior written notice to COUNTY and subject to Paragraph 32, LANDLORD and its authorized employees, contractors, and agents shall have the right to enter the Premises at all reasonable times during COUNTY's normal business hours, excluding any COUNTY holidays, for any of the following purposes: (i) to determine COUNTY's compliance with its obligations under the Lease; (ii) to perform any necessary maintenance, repair, and restoration of the Premises pursuant to the Lease; (iii) to serve, post, or keep posted any notices required by law; and (iv) to post "for sale" signs at any time during the Lease Term or to post "for rent" or "for lease" signs during the last three (3) months of the Lease Term, provided such signs do not unreasonably interfere with the conduct of COUNTY operations. LANDLORD's entry shall be made in a manner that will cause the least possible inconvenience, annoyance, or disturbance to COUNTY.

28. **SURRENDER.** Upon the expiration or earlier termination of the Lease, COUNTY shall surrender the Premises in as good a condition as received on the Commencement Date, excluding reasonable wear and tear, LANDLORD's obligations pursuant to the Lease, casualty damages, and the removal of the Improvements and any other improvements or alterations in accordance with the Lease. In the event, COUNTY has pre-paid any Monthly Rent or other sums for the Premises, LANDLORD shall, within thirty (30) days after the expiration or earlier termination of the Lease, return to COUNTY any unearned Monthly Rent or other sums.

29. **ESTOPPEL CERTIFICATES.** In the event of a sale or financing of the Property by LANDLORD or an assignment of the Lease or leasehold financing by COUNTY, the LANDLORD or COUNTY, as the case may be, shall execute an estoppel certificate to the requesting party's purchaser, assignee, or lender, as the case may be, which estoppel certificate shall substantially be in the form of Exhibit "E", attached hereto and incorporated herein, to confirm those certain terms of the Lease. COUNTY's RESD Director shall have the authority on behalf of COUNTY to execute an estoppel certificate substantially in the form of Exhibit "E".

30. **SUBORDINATION AND ATTORNMENT.**

A. As a condition precedent to COUNTY's obligations under the Lease, LANDLORD shall obtain from each holder of a lien or encumbrance on the Premises which is senior to the Lease either an executed recordable subordination agreement which subordinates such lien or encumbrance to the Lease, or a non-

disturbance agreement, substantially in the form of the attornment provisions in Exhibit "F", attached hereto and incorporated herein by reference.

B. If, after execution of the Lease, a subsequent lienor requires that the Lease be subordinate to any such encumbrance, the Lease shall be subordinate to that encumbrance if, and only if, LANDLORD first obtains from the subsequent lienor an executed subordination, nondisturbance and attornment agreement ("SNDA"), substantially in the form of Exhibit "F". COUNTY's RESD Director shall have the authority on behalf of COUNTY to execute a SNDA substantially in the form of Exhibit "F".

31. **PUBLIC RECORDS DISCLOSURE.** LANDLORD acknowledges and agrees that all information received by COUNTY from LANDLORD or any source concerning the Lease or the Property, including the Lease itself, may be treated by COUNTY as public information, subject to disclosure under the provisions of the California Public Records Act (Government Code Section 6250 et seq.), the Ralph M Brown Act, or any other open records laws ("Public Records Laws"). LANDLORD further acknowledges and agrees that, although all information received by COUNTY in connection with the Lease or the Property are intended for the exclusive use of COUNTY, such information is potentially subject to disclosure under Public Records Laws. In the event LANDLORD, at the time any information is provided to COUNTY, has reasonably requested in writing that certain information as to the Lease or the Property be held in confidence and a request for disclosure of such information is thereafter received by COUNTY, COUNTY shall endeavor to notify LANDLORD of said request and shall thereafter disclose the requested information unless LANDLORD, within five (5) days of COUNTY's notice of such disclosure request: (i) requests that the information not be disclosed; (ii) provides a legally sound basis for nondisclosure (as determined in COUNTY's sole discretion); and (iii) agrees in writing to indemnify, defend (with counsel reasonably approved by COUNTY), and hold harmless COUNTY and its officers, employees, agents, and volunteers from any and all claims, actions, losses, damages, and/or liability arising out of or related the required disclosure. Notwithstanding anything to the contrary in the Lease, if COUNTY does not notify LANDLORD of such disclosure request or if COUNTY does not deem LANDLORD's basis for nondisclosure to be legally sufficient, as determined by COUNTY in its sole discretion, COUNTY shall not be liable for any claims for damages, lost profits, or other injuries of any and all kinds and LANDLORD waives any and all such claims against COUNTY. LANDLORD's indemnity obligation shall survive the expiration or earlier termination of the Lease.

32. **CONFIDENTIALITY.** LANDLORD acknowledges that the Premises will be used by COUNTY for the processing and storage of confidential information that is protected from unlawful access and disclosure by municipal, county, state, and federal laws ("Confidential Information"). LANDLORD and its officers, agents, volunteers, employees, contractors, and any third parties under LANDLORD's control (including, but not limited, to property management, maintenance, and custodial providers) hereby agree to comply with all applicable municipal, county, state, and federal laws pertaining to the security and protection of Confidential Information and will prevent and not permit any unlawful access to or disclosure of Confidential Information when entering the Premises as permitted by the Lease. Prior to any permitted entry of the Premises, except in the event of an emergency or an imminent and substantial damage or destruction of the Premises, LANDLORD and its officers, agents, volunteers, employees, contractors and any third parties under LANDLORD's control shall: (i) provide not less than twenty-four (24) hours prior written notice of its desired entry; (ii) enter only during COUNTY's normal business hours; (iii) be escorted by COUNTY during its entry; and (iv) remain in the Premises only for so long as reasonably necessary to complete LANDLORD's obligations under the Lease. Should it be necessary for LANDLORD to enter the Premises due to a emergency or imminent and substantial damage or destruction of the Premises, LANDLORD and its agents, volunteers, employees, contractors, and any third parties under LANDLORD's control shall: (a) immediately notify COUNTY of such entry, (b) remain in the Premises only for so long as reasonably necessary to abate such emergency or destruction, and (c) upon departure, secure the Premises in the same manner as the Premises were secured upon entry, (i.e., arming alarm system and locking entry points). During any permitted entry of the Premises, LANDLORD and its officers, agents, volunteers, employees or any third parties under LANDLORD's control shall not access, disclose, or remove any Confidential Information from the Premises, including but not limited to, access of file cabinets, locked storage rooms, and desks. Any entry of the Premises that does not comply with the requirements of this paragraph is unauthorized. LANDLORD agrees to include the entry requirements contained in this paragraph in its agreements with all third-party providers who may enter the Premises. LANDLORD acknowledges that any unlawful access to or disclosure of Confidential Information may result in the imposition of civil and criminal sanctions.

33. **FORMER COUNTY OFFICIALS.** LANDLORD has set forth on Exhibit "G" of the Lease certain information on former COUNTY administrative officials (as defined below) who are employed by or represent LANDLORD. The information provided includes a list of the full names of former COUNTY administrative officials who terminated COUNTY employment within the last five years and who are now officers, principals, partners, associates or members of LANDLORD. The information should also include the title/description of the official's last position with COUNTY, the date the official terminated COUNTY employment, the official's current employment and/or representative capacity with LANDLORD, and the date the official entered LANDLORD's employment and/or representation. For purposes of this provision, "COUNTY administrative official" is defined as a member of the Board of Supervisors or such officer's staff, COUNTY Administrative Officer or member of such officer's staff, COUNTY department or group head, assistant department or group head, or any employee in the Exempt Group, Management Unit or Safety Management Unit.

34. Intentionally Omitted.

35. **NOTICES.**

A. Any notice, demand, request, consent, approval or communication that either party desires or is required to give to the other party, including but not limited to, notices required under the California unlawful detainer statutes, or any other person shall be in writing and either served personally, delivered by a reputable overnight courier service, or sent by postage prepaid, first-class United States mail, certified or registered, return receipt requested. Any notice, demand, request, consent, approval or communication that either party desires or is required to give to the other party shall be addressed to the other party at the addresses set forth in the Basic Lease Provisions. Either party may change its address by notifying the other party of the change of address. Notices shall be deemed delivered upon the earlier of: (i) actual receipt if such notice is personally delivered; (ii) the date of delivery if such notice is delivered by a reputable overnight courier service; or (iii) the date of delivery or refusal of the addressee to accept delivery if such notice is sent by postage pre-paid, first-class United States mail, certified or registered, return receipt requested. Any notices received after 5 pm local time on a business shall be deemed delivered on the following business day.

B. If, at any time after the Commencement Date, LANDLORD intends to transfer its ownership interest (whether controlling or non-controlling) in the Property to a third party, LANDLORD shall notify COUNTY of such transfer at least fifteen (15) COUNTY working days prior to completion of such transfer. In the event of a transfer of controlling interest in the Property, LANDLORD and the new owner shall provide COUNTY with evidence of completion of transfer; in which case, the new owner and COUNTY shall document by written amendment said change of ownership. In addition, the new owner shall, within five (5) of acquiring the Property, provide COUNTY with evidence that it has obtained insurance in compliance with Paragraph 19, INDEMNIFICATION and Paragraph 20, INSURANCE REQUIREMENTS AND SPECIFICATIONS. The COUNTY's RESD Director shall have the authority on behalf of COUNTY to execute a COUNTY standard amendment to this Lease with any new LANDLORD solely for the purposes of reflecting any changes in the legal ownership of the Property and to update the LANDLORD's notice address in the Basic Lease Provisions. The new LANDLORD acknowledges and agrees new LANDLORD execution of such COUNTY standard amendment is a pre-requisite for Rents under this Lease to be paid to the new LANDLORD.

36. **BROKER'S COMMISSIONS.** LANDLORD is solely responsible for the payment of any commissions to any broker who has negotiated or otherwise provided services in connection with the Lease and shall indemnify, defend (with counsel reasonably approved by COUNTY) and hold harmless COUNTY and its officers, employees, agents, and volunteers from any and all claims, actions, losses, damages, and/or liability arising out of or related to LANDLORD's default of this obligation. LANDLORD's indemnity obligation under this Lease shall survive the expiration or earlier termination of the Lease.

37. **ATTORNEYS' FEES AND COSTS.** If any legal action is instituted to enforce or declare a Party's rights hereunder, each Party, including the prevailing Party, must bear its own attorneys' fees and costs. This paragraph shall not apply to those attorneys' fees and costs directly arising from any third-party legal action against COUNTY, including such attorneys' fees and costs payable under Paragraph 13, HAZARDOUS SUBSTANCES, Paragraph 19, INDEMNIFICATION, Paragraph 31, PUBLIC RECORDS DISCLOSURE; and Paragraph 32, CONFIDENTIALITY.

38. **NO PARTNERSHIP.** Neither Party shall, in any way or for any purpose, become a partner of the other Party in the conduct of its business, or otherwise, or joint venturer or a member of a joint enterprise with the other Party as a result of execution of the Lease.
39. **BINDING EFFECT.** The Lease is binding upon and inures to the benefit of the Parties and their respective successors, assigns, heirs, executors, and administrators.
40. **JOINT AND SEVERAL LIABILITY.** In the event that one or more individuals and/or entities comprise LANDLORD, all obligations of each individual and/or entity named as LANDLORD under the Lease are joint and several and may not be waived or apportioned except by written consent of COUNTY. COUNTY may recover monies due or remedies available from any one or all individuals and/or entities named as LANDLORD under the Lease at COUNTY's sole option.
41. **SURVIVAL.** The obligations of the Parties that, by their nature, continue beyond the term of the Lease, will survive the expiration or earlier termination of the Lease.
42. **QUIET ENJOYMENT.** Provided that COUNTY is not in default beyond any applicable notice and cure periods, COUNTY shall, at all times during the Lease Term, have quiet and peaceful possession and enjoyment of the Premises against any persons claiming by, through or under LANDLORD or any third parties.
43. **TIME OF ESSENCE.** Time is of the essence of each provision of the Lease which specifies a time within which performance is to occur. In the absence of any specific time for performance, performance may be made within a reasonable time.
44. **CONSENT.** Unless otherwise expressly provided otherwise in the Lease, whenever consent or approval of either Party is required, that Party shall not unreasonably withhold, condition, or delay such consent or approval.
45. **INTERPRETATIONS.** As the Lease was jointly prepared by the Parties, the language in all parts of the Lease shall be construed, in all cases, according to its fair meaning, and not for or against either party hereto.
46. **HEADINGS.** The headings of any paragraphs, sub-paragraphs, table of contents, and cover page of the Lease are for convenience and reference only and shall have no effect on its interpretation.
47. **PROVISIONS ARE COVENANTS AND CONDITIONS.** All provisions, whether covenants or conditions, on the part of either Party shall be deemed to be both covenants and conditions.
48. **LAW.** The Lease shall be governed by and construed in accordance with the laws of the State of California.
49. **VENUE.** The parties acknowledge and agree that the Lease was entered into and intended to be performed in the County of San Bernardino, California. The parties agree that the venue for any action or claim brought by any party to the Lease will be the Superior Court of California, County of San Bernardino. Each party hereby waives any law, statute (including but not limited to Code of Civil Procedure section 394), or rule of court that would allow them to request or demand a change of venue. If any third party brings an action or claim concerning the Lease, the parties hereto agree to use their best efforts to obtain a change of venue to the Superior Court of California, County of San Bernardino.
50. **EXHIBITS.** All exhibits referred to in the Lease are attached hereto and incorporated herein by reference.
51. **ENTIRE AGREEMENT.** The Lease contains the entire agreement of the Parties with respect to the subject matter hereof and supersedes all prior and contemporaneous agreements and understandings, express or implied, oral or written, of any nature whatsoever with respect to the subject matter hereof.

52. **AMENDMENTS.** The Lease shall not be amended or modified except by written agreement executed by the Parties.

53. **WAIVERS.** No waiver by either Party of any provisions of the Lease shall be effective unless given in writing by such Party and a waiver given in one instance shall not be deemed to be a waiver of any other provision hereof or of any subsequent default by either party of the same or any other provisions.

54. **SEVERABILITY.** If any word, phrase, clause, sentence, paragraph, section, article, part or portion of the Lease is or shall be invalid for any reason, the same shall be deemed severable from the remainder hereof and shall in no way affect or impair the validity of the Lease or any other portion thereof.

55. **COUNTERPARTS.** The Lease may be executed in any number of counterparts, each of which so executed shall be deemed to be an original, and such counterparts shall together constitute one and the same Lease. The parties shall be entitled to sign and transmit an electronic signature of this Lease (whether by facsimile, PDF or other email transmission), which signature shall be binding on the party whose name is contained therein. Each party providing an electronic signature agrees to promptly execute and deliver to the other party an original signed Lease upon request.

56. **AUTHORIZED SIGNATORS.** The Parties to the Lease represent that the signators executing this document are fully authorized to enter into this agreement.

57. **CAMPAIGN CONTRIBUTION DISCLOSURE (SB 1439).**

LANDLORD has disclosed to the County using Exhibit I - Campaign Contribution Disclosure Senate Bill 1439, whether it has made any campaign contributions of more than \$250 to any member of the Board of Supervisors or other County elected officer [Sheriff, Assessor-Recorder-Clerk, Auditor-Controller/Treasurer/Tax Collector and the District Attorney] within the earlier of: (1) the date of the submission of LANDLORD's proposal to the County, or (2) 12 months before the date this Lease was approved by the Board of Supervisors. LANDLORD acknowledges that under Government Code section 84308, LANDLORD is prohibited from making campaign contributions of more than \$250 to any member of the Board of Supervisors or other County elected officer for 12 months after the County's consideration of the Lease.

In the event of a proposed amendment to this Lease, the LANDLORD will provide the County a written statement disclosing any campaign contribution(s) of more than \$250 to any member of the Board of Supervisors or other County elected officer within the preceding 12 months of the date of the proposed amendment.

Campaign contributions include those made by any agent/person/entity on behalf of the LANDLORD or by a parent, subsidiary or otherwise related business entity of LANDLORD.

58. **FORCE MAJEURE.**

Except for County's monetary obligations under the Lease, to which this section shall not apply, and provided that each party is exercising all due diligence, neither LANDLORD nor COUNTY shall be held liable for any of its respective delay or failure in performance of any part of this Lease due to any cause beyond its reasonable control and without its fault or negligence, such as acts of God, acts of civil or military authority, strikes, embargoes, epidemics, governmental or administrative delays, war, terrorist acts, riots, insurrections, earthquakes, nuclear accidents, power blackouts, brownouts, volcanic action and inability to secure product or services of other persons or transportation facilities for which comparable alternatives are unavailable and each party's obligations shall be extended for the period equivalent to the period of such delay, provided that if either party alleges the occurrence of a force majeure event, said party shall provide written notice to the other party within 30 days after the occurrence of such event, with a time estimate for the anticipated duration of such event, which is subject to verification by the other party and the party claiming force majeure shall provide documentation reasonably requested for such verification. In the event either party fails to timely notify the other in writing of any such force majeure delay, the provisions of this Paragraph 58 shall not apply to such delay and the respective party's obligations shall remain unmodified.

IN WITNESS WHEREOF, the parties hereto have caused the Lease to be executed.

COUNTY:
SAN BERNARDINO COUNTY

LANDLORD:

By: _____
Dawn Rowe, Chair
Board of Supervisors

By: _____
(name)

Title: _____

Date: _____

Date: _____

SIGNED AND CERTIFIED THAT A COPY OF
THIS DOCUMENT HAS BEEN DELIVERED TO
THE CHAIRMAN OF THE BOARD

By: _____
(name)

Lynna Monell
Clerk of the Board of Supervisors
San Bernardino County

Title: _____

Date: _____

By: _____
Deputy

Date: _____

Approved as to Legal Form:

TOM BUNTON, County Counsel
San Bernardino County, California

By: _____
John Tubbs II, Deputy County Counsel

Date: _____

EXHIBIT "A"

PREMISES

**OFFICE SPACE AT 735 EAST CARNEGIE DRIVE, SUITE 200
SAN BERNARDINO, CA**

**APN #0281-36-126-0000
(Within the Red Border)**

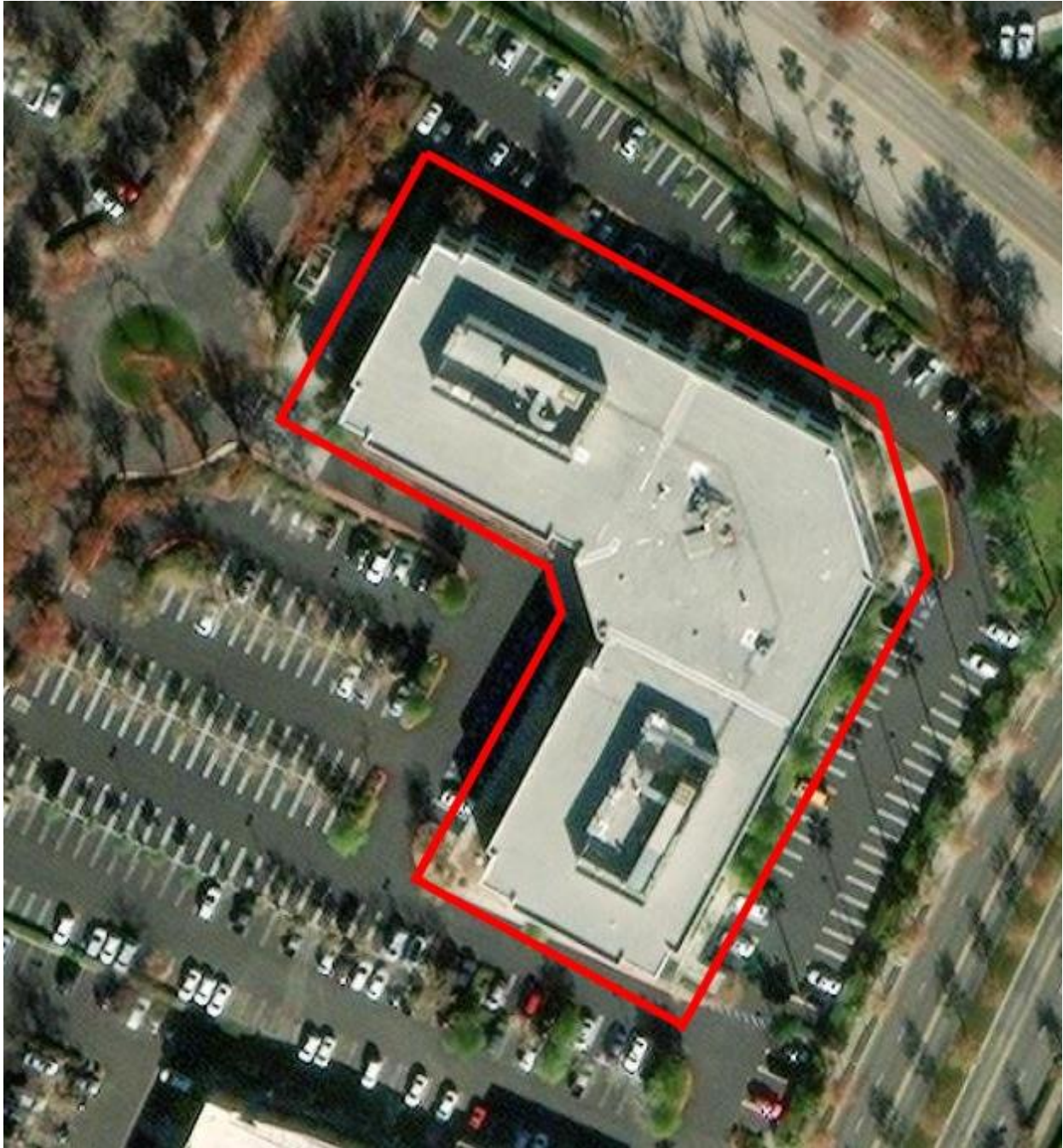

EXHIBIT "A-1"

SITE PLAN

**OFFICE SPACE AT 735 EAST CARNEGIE DRIVE, SUITE 200
SAN BERNARDINO, CA**

(Within Green Shaded Area)

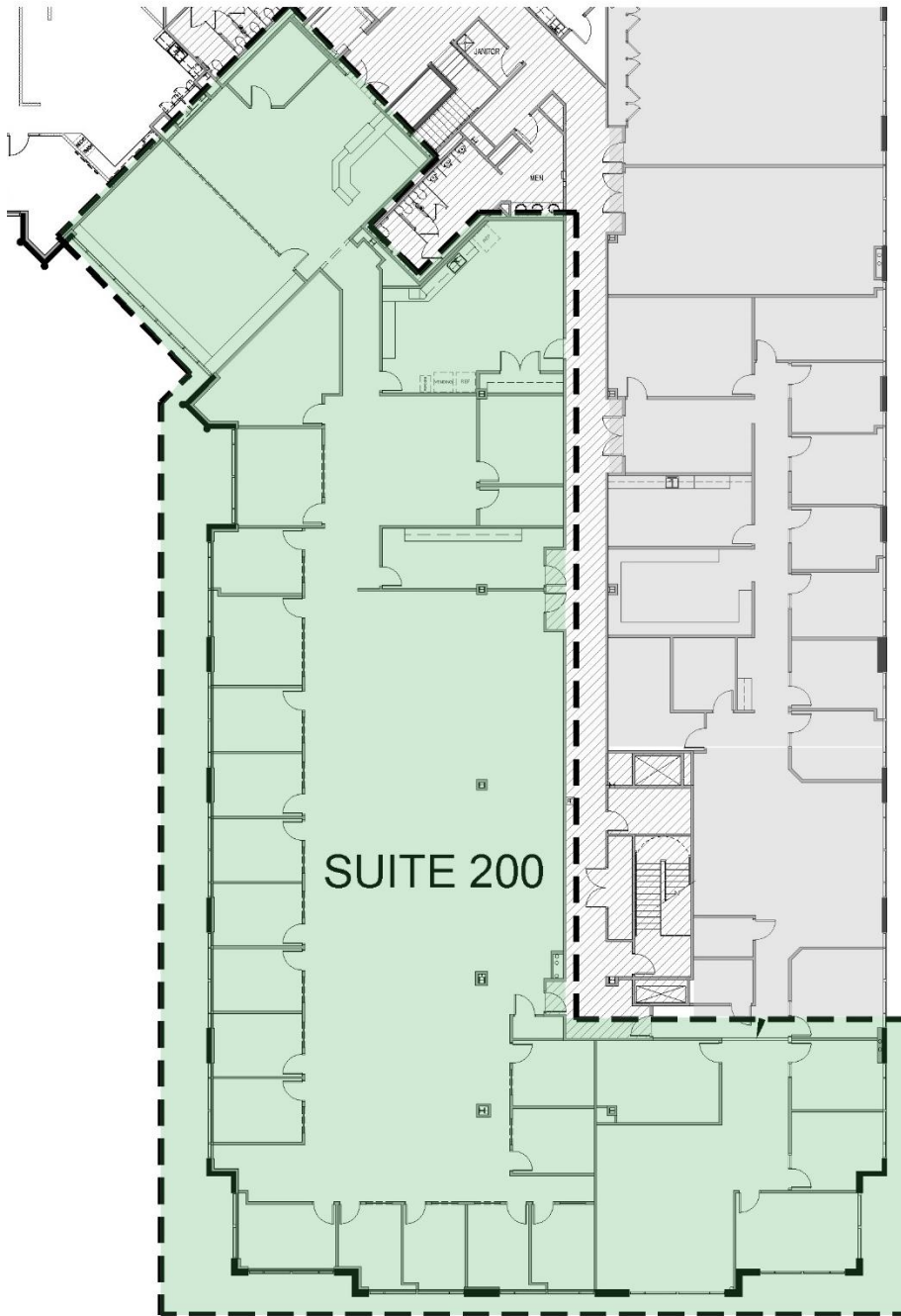

EXHIBIT "B"

IMPROVEMENT WORK LETTER

Concurrently with the execution of this Improvement Work Letter, LANDLORD and COUNTY have entered into the Lease for the Premises. All terms not defined herein have the same meaning as set forth in the Lease. To the extent applicable, the provisions of the Lease are incorporated herein by this reference.

1. LANDLORD shall, at its sole cost and expense, construct the improvements ("Improvements") at the Premises and, if applicable, at the Building and the Property in accordance with the plans and specifications set forth on Exhibit B-2, Premises Design Standards And Specifications, attached hereto and incorporated herein by reference (the "Improvement Specifications"), this Improvement Work Letter, and the Lease, including but not limited to Paragraph 12, LEGAL COMPLIANCE, provided that the cost of the Improvements is amortized over the Lease Term and such amortized amount is payable monthly as set forth in the Basic Lease Provisions. Any increase in the cost of the Improvements after the mutual execution of the Lease shall be LANDLORD's sole responsibility regardless of cause except if such cost increase is due to a COUNTY Change Order (as later defined). LANDLORD shall contribute a Tenant Improvement Allowance in the maximum amount of \$197,520.00 (\$15.00 per square foot) to the design, permitting, labor, materials and other construction costs for the Improvements for COUNTY at the Premises. Tenant Improvement allowance to be applied to mutually approved COUNTY specifications. COUNTY acknowledges that LANDLORD has made no representations as to the total cost of construction which will be completed by third-party contractors. COUNTY agrees that any design, permitting, and construction costs exceeding the Tenant Improvement allowance, up to an additional \$50.00 PSF will be amortized and the entirety of such amount shall be paid by COUNTY to LANDLORD at \$0.61 per square foot throughout the term of the Lease as specified in the monthly rent for the premises (Section I, Paragraph K) ("Amortized Allowance").

2. LANDLORD shall, as part of the Tenant Improvement Allowance or Amortized Allowance, furnish all of the design, material, labor and equipment required to construct the improvements and shall cause its contractor to apply for and obtain, all permits, licenses, certificates, and approvals necessary for the construction of the Improvements. LANDLORD shall cause its architect to provide all site plans for the Premises, the Building, and the Property, including Building elevations and exterior finishes, space design plans, construction plans, and a complete set of the bid drawings and specifications as required by the governmental authority issuing permits ("Drawings"). The bid drawings shall be provided to COUNTY on reproducible transparent vellum with the architect's/engineer's professional stamp and signature and on a flash drive (USB) in an Adobe Acrobat file format (.pdf file extension) and on AutoCAD software (.dwg file extension). The plans and specifications for the Improvements shall be submitted as a reproducible hardcopy and copied on a flash drive (USB) with formats compatible with Microsoft Office.

3. LANDLORD shall not modify the Improvements without obtaining the prior written consent of the COUNTY's RESD representative, as the authorized COUNTY agent for the Improvements, which consent shall not be unreasonably withheld, conditioned or delayed. COUNTY shall timely approve the Drawings or any other matter requiring Tenant's approval or consent. In the event LANDLORD makes any modifications to the Improvements without COUNTY's prior written consent, COUNTY shall have no liability for any costs incurred and LANDLORD shall be solely responsible for said costs and for any costs incurred to return the affected portion of the Improvements to its original specifications. During construction of the Improvements, if COUNTY's authorized COUNTY RESD representative proposes any modifications to or additional work that are not set forth in Exhibit "B-2", Improvement Specifications, LANDLORD shall, prior to commencing any proposed work, promptly provide pricing and schedule impacts to COUNTY for the proposed work. If the parties mutually agree to proceed with the proposed modification or additional work to the Improvements ("COUNTY Change Order Work"), the authorized representatives of the Parties shall execute a change order document ("COUNTY Change Order") setting forth the agreed specifications, costs, and schedule impact, if any, for the COUNTY Change Order Work and LANDLORD shall promptly complete said COUNTY Change Order Work. In the event that LANDLORD provides COUNTY with notice of a change order and COUNTY fails to respond within 15 business days, the COUNTY shall be deemed to have approved such change order and agrees to be responsible for said costs related thereto, not to exceed \$50,000. In addition to the cost of the COUNTY Change Order Work, COUNTY shall pay LANDLORD an administrative fee calculated at ten percent (10%) of the cost of the COUNTY

Change Order Work. Upon LANDLORD's Substantial Completion of the COUNTY Change Order Work and acceptance of the Improvements for COUNTY's intended use, subject to latent defects and the representations, warranties, and provisions of the Lease. COUNTY shall pay LANDLORD for the COUNTY Change Order Work by separate purchase order (and not by additional amortization into the rent) within ninety (90) days after COUNTY's receipt of an itemized invoice, proof of payment, lien releases, and any other documents requested by COUNTY for the COUNTY Change Order Work. The authorized COUNTY RESD representative may process one or more COUNTY Change Orders in accordance with this Paragraph 3, provided that, notwithstanding anything to the contrary in the Lease or this Improvement Work Letter, the cumulative total of all agreed COUNTY Change Orders shall not exceed \$50,000 unless otherwise agreed in writing by COUNTY. Any proposed COUNTY Change Order(s) that cause the cumulative total of all agreed COUNTY Change Orders to exceed \$50,000 shall be processed by a mutually agreed amendment to the Lease that is executed by the parties.

4. In the event LANDLORD contracts for the construction of the Improvements or any portion thereof, LANDLORD shall comply with the provisions of the California Public Contract Code 22000 through 22045 regarding bidding procedures and Labor Code Section 1720.2 and 1770 et seq. regarding general prevailing wages, if applicable under California state law, including, but not limited to, those requirements set forth on Exhibit "H", attached hereto and incorporated herein by reference. LANDLORD shall indemnify, defend (with counsel reasonably approved by COUNTY) and hold harmless COUNTY and its officers, employees, agents, and contractors from any and all claims, actions, losses, damages and/or liability arising out of or related to the obligations set forth in this paragraph. LANDLORD's indemnity obligations shall survive the expiration or earlier termination of the Lease and such obligations shall not be limited by the existence or availability of insurance.

5. Following the mutual execution of the Lease, Landlord shall promptly and diligently proceed with the construction of the Improvements and use reasonable speed, diligence, and good faith efforts to Substantially Complete the Improvements within a reasonable time period considering the design, plans, permitting, labor, materials and construction process. The Improvements shall be deemed "Substantially Complete" upon the occurrence of all of the following: (i) LANDLORD has delivered notice to COUNTY that the Improvements are substantially complete in accordance with the Specifications, subject only to minor punchlist items as mutually agreed by the Parties; (ii) COUNTY's receipt of a temporary certificate of occupancy for the Premises, and if applicable, the Building and the Property, issued by all relevant governmental authorities; and (iii) written acceptance by an authorized agent of COUNTY for the Improvement for COUNTY's intended use, subject to latent defects and the representations, warranties, and provisions of the Lease.

6. All punchlist items shall be completed by LANDLORD within a reasonable time period and LANDLORD shall use commercially reasonable efforts to complete such punch list items within thirty (30) days after the LANDLORD and COUNTY have conducted a walk-through and reviewed the Improvements following LANDLORD's delivery of notice that they are Substantially Completed. In the event that LANDLORD fails to complete said punchlist items within said time period and the Commencement Date has occurred, for the period of time from the Commencement Date through the time that the punchlist items are all completed, COUNTY shall only pay eighty percent (80%) of the Monthly Rent and other sums due under the Lease with the remaining twenty percent (20%) of the Monthly Rent and other sums due to accrue but shall not be paid to LANDLORD until all such punchlist items have been completed and agreed by COUNTY. If COUNTY withholds Monthly Rent or other sums due under this paragraph, COUNTY shall not be in default of the Lease and no interest or service charges shall be added to the amounts due LANDLORD upon completion of the punchlist items.

7. In order to meet the Projected Occupancy Date, the Parties agree on the following schedule for each of the construction milestones.

<u>Milestones</u>	<u>Projected Milestone Completion Date</u>	<u>Critical Milestone Completion Date</u>
Improvement plan preparation and submittal to San Bernardino City ("City")	October 1, 2024	October 15, 2024
Approval and permit Issuance for Improvements	December 15, 2024	January 15, 2025
Construction of Improvements and Finally Certified for Occupancy by City	July 1, 2025	August 1, 2025

8. LANDLORD shall provide COUNTY with a written progress report every thirty (30) days during the construction of the Improvements. The report shall contain the most current information regarding progress, completions, and delays for each milestone of the construction schedule. LANDLORD shall further provide COUNTY with written notice upon LANDLORD's completion of each milestone of the above construction schedule. COUNTY and its representatives shall be given reasonable notice of and may attend all project meetings, including all design review meetings and construction meetings. At COUNTY's option, Landlord shall meet with COUNTY monthly (or more frequently if reasonably required by COUNTY) to provide detailed progress reports.

9. LANDLORD acknowledges and agrees that its failure to meet any of the above Projected Completion Date(s) will mean that LANDLORD will not be able to deliver the Premises with all Improvements Substantially Completed by the Projected Occupancy Date. LANDLORD further acknowledges and agrees that late delivery to COUNTY of the Premises with all Improvements Substantially Completed will cause COUNTY to incur costs not contemplated by the Lease, the exact amount of such costs being extremely difficult and impracticable to fix. Therefore, if LANDLORD fails to meet any of the above Projected Completion Date(s) or fails to deliver the Premises with all Improvements Substantially Completed by the Projected Occupancy Date, LANDLORD agrees to pay COUNTY liquidated damages in the amount of Five Hundred and 00/00 Dollars (\$500.00) for each day of delay, commencing on the day immediately following the Projected Occupancy Date until the day the Projected Occupancy Date occurs. The parties agree that this amount for liquidated damages represents a fair and reasonable estimate of the costs that COUNTY will incur by reason of late delivery. Acceptance of any amount of liquidated damages shall not constitute a waiver of LANDLORD's default or prevent COUNTY from exercising any of the other rights and remedies available to COUNTY at law or in equity.

10. In the event that LANDLORD fails to meet any of the above Critical Completion Date(s) or the does not deliver the Premises with all Improvement Substantially completed by August 1, 2025 ("Critical Occupancy Date"), COUNTY shall have the right to elect to terminate the Lease upon written notice to LANDLORD; in which event, neither Party shall have any further obligations to the other, except for those obligations that expressly survive the termination of the Lease. In the event that COUNTY elects to so terminate the Lease, COUNTY's election shall be in writing and shall be given after the subject Projected Completion Date, Critical Completion Date, or Critical Substantial Completion Date has been missed but prior to LANDLORD's completion of the subject milestone completion and LANDLORD's notification of the same to COUNTY.

11. Notwithstanding Paragraphs 6, 7, and 8 of this Improvement Work Letter, in the event LANDLORD, after exercising all due diligence, is unable to meet any of the above mentioned Projected or Critical Completion Dates or the Projected or Critical Occupancy Date(s) due to reasons which LANDLORD proves are outside the control of LANDLORD, such reasons include but are not limited to acts of God, unreasonable acts of governmental agencies causing unavoidable delays (the normal and reasonable times for review, action and reasonably anticipated delays by governmental agencies are already included in the timing of the Critical Completion Dates), utility delays, strikes, material shortages, or labor troubles, then the Projected or Critical Completion Dates(s) or

the Projected or Critical Occupancy Date(s) shall be extended for a period equivalent to the period of such delay, provided that as soon as LANDLORD becomes aware or should in the exercise of due diligence have become aware of any facts or circumstances that may or will cause such a delay, LANDLORD shall immediately provide written notice to COUNTY of any such delay or anticipated delay. In the event LANDLORD fails to timely notify COUNTY in writing of any such delay or anticipated delay, the provisions of this Paragraph 11 shall not apply to such delay or anticipated delay and the Projected or Critical Completion Dates or the Projected or Critical Occupancy Date(s) shall remain unmodified.

12. Until the Improvements are Substantially Completed and all minor punchlist items have been completed, LANDLORD understands and agrees that LANDLORD shall not sell the Property, assign the Lease, or transfer a controlling interest in LANDLORD person or entity or the Premises to a third party ("Transfer") without COUNTY's prior review and written approval, which approval shall not be unreasonably withheld, conditioned or delayed. In the event LANDLORD desires to make a Transfer, LANDLORD shall submit a written request to COUNTY along with all relevant documents regarding the proposed Transfer to COUNTY for its review and consent. COUNTY's consent shall be deemed denied in the event COUNTY does not respond to LANDLORD's Transfer request. In the event COUNTY consents to LANDLORD's Transfer request, the Parties shall execute an amendment to the Lease to confirm the Transfer.

13. During construction of the Improvements, LANDLORD shall allow COUNTY to: (i) have early access ("Early Access") to the Premises at no cost and at any time prior to the Commencement Date for the purpose of COUNTY or its representatives installing communications equipment, modular furniture, alarms and such other items that COUNTY may reasonably desire and to inspect the status of the construction of the Improvements, provided that nothing herein contained shall be construed as creating an obligation upon COUNTY to make such inspections, and it is Landlord's obligation to insure that the Improvements are completed in compliance with the plans and specifications COUNTY shall exercise its Early Access rights at a time and in a manner that will not unreasonably interfere with LANDLORD's construction of the Improvements and any such Early Access shall not affect the Commencement Date or the Expiration Date; and/or (iii) have early use ("Early Use") of the Premises or any portion thereof at any time prior to the Commencement Date. COUNTY shall exercise its Early Use rights at a time and in a manner that will not unreasonably interfere with LANDLORD's construction of the Improvements. If COUNTY exercises its Early Use rights as to the Premises or any portion thereof, the terms of the Lease shall be in effect, provided if COUNTY's Early Use is as to a portion of the Premises, Monthly Rent shall be pro-rated based on the area of COUNTY's Early Use and such Early Use or vacation thereof shall not constitute COUNTY's acceptance of the Premises or the Improvements or any portion thereof as Substantially Complete. Any such Early Use shall not affect the Commencement Date or the Expiration Date. All other terms of the Lease shall, however, be in effect during such period.

14. For a period of one (1) year from Substantial Completion, the Improvements shall be warranted by Landlord's contractor against defects in design, materials and workmanship. Without limiting Landlord's repair obligations to the extent expressly set forth in the Lease, Landlord shall, at Landlord's expense, promptly repair or replace any such defective Improvement evidenced by written notice from County to Landlord within such one (1) year period.

15. During the Lease Term, Landlord shall cause its contractor to warrants the Improvements against all latent defects and the failure of the Improvements to be completed in accordance with the plans and specifications. The warranties set forth in Paragraph 14 and Paragraph 15 herein cover all design, labor, materials and equipment required to perform any required repairs or other remediation resulting from the breach of any such warranty. Upon and following Substantial Completion, Landlord shall enforce for the benefit of County all such warranties and guarantees relating to the Improvements and all equipment and building systems comprising a portion of the Improvements. Landlord's failure to honor any such warranty made by Landlord shall be a default by Landlord under the Lease.

IN WITNESS WHEREOF, LANDLORD and COUNTY have caused this Improvement Work Letter to be duly executed by their authorized representatives as of the date of the Lease.

COUNTY:
SAN BERNARDINO COUNTY

LANDLORD:

By: _____
Dawn Rowe, Chair
Board of Supervisors

By: _____
(name)

Date: _____

Title: _____

Date: _____

SIGNED AND CERTIFIED THAT
A COPY OF THIS DOCUMENT
HAS BEEN DELIVERED TO THE
CHAIR OF THE BOARD

By: _____
(name)

LYNNA MONELL, Clerk of the Board of
Supervisors

Title: _____

Date: _____

By: _____
Deputy

Date: _____

Approved as to Legal Form:

Tom Bunton, County Counsel
San Bernardino County, California

By: _____
John Tubbs II, Deputy County Counsel

Date: _____

EXHIBIT "B-1" FLOORPLAN (DRAFT)

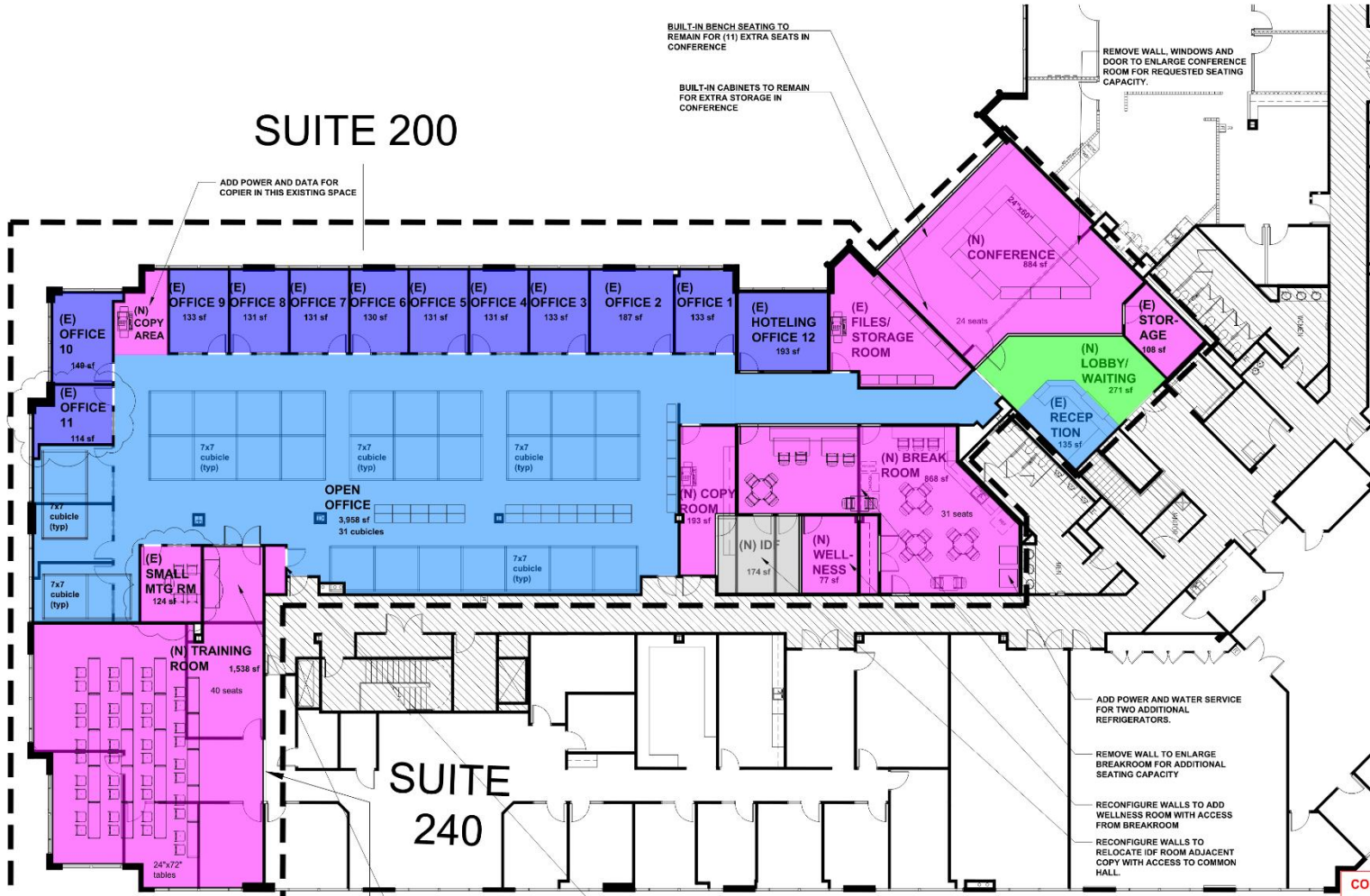

GENERAL NOTES

- REFER TO "EXHIBIT A-1" IN LEASE AGREEMENT FOR DESIGN STANDARDS AND SPECIFIC IMPROVEMENTS LISTED BY ROOM NUMBER.
- THIS PLAN IS NOT FOR CONSTRUCTION. IT IS FOR CONCEPTUAL REFERENCE ONLY.
- DO NOT SCALE PLANS. DIMENSIONS AND NOTES TAKE PRECEDENCE OVER SCALE OF PLANS.
- THIS CONCEPT PLAN WAS DRAWN FROM A PLAN DRAWN BY OTHERS. ACCURACY IS NOT GUARANTEED. IF THERE IS AN ERROR OR OMISSION ON THESE PLANS, PLEASE CONTACT DINA BUNCH AT 909-454-5657.

METRICS

- 12 OFFICES
- 33 CUBICLES INCLUDING RECEPTION
- PUBLIC WAITING AREA
- 1 BREAKROOM
- 2 CONFERENCE ROOMS
- 1 TRAINING ROOM
- 1 WELLNESS ROOM
- 1 SET PUBLIC RESTROOMS
- 3 COPIER AREAS
- 1 IDF ROOM
- TOTAL USEABLE SQUARE FEET IS 13,875.

LEGEND

- BUILDING OR FLOOR COMMON AREAS.
- PUBLIC RESTROOMS.
- AMENITY AREAS.
 - BREAKROOMS
 - CONFERENCE, MEDIA STORAGE, COPY, FILE, VIRTUAL TRAINING, INTERVIEW, ETC.
- PRIVATE OFFICES
- OPEN OFFICE AREAS
- LOBBY AREAS
 - CLIENT CIRCULATION
- SERVICE AREAS
 - EMPLOYEE RESTROOM, JANITOR, ELECTRICAL, DATA/COMM, FIRE RISER

CONCEPTUAL FLOOR PLAN APPROVAL

ACCEPTED TO PROCEED ACCEPTED WITH CHANGES NOTED

REVISE AND RESUBMIT REJECTED

THE SPACE LAYOUT OPTION DEPICTED ON THIS DRAWING SHEET IS ACCEPTED BY THE UNDERIGNED AS NOTED ABOVE.

BY: _____ DATE: _____

AUTHORIZED REPRESENTATIVE FOR CLIENT DEPARTMENT

Dina Bunch

CLIENT DEPARTMENT

SUITE 200

SUITE 240

BUILT-IN BENCH SEATING TO REMAIN FOR (11) EXTRA SEATS IN CONFERENCE

BUILT-IN CABINETS TO REMAIN FOR EXTRA STORAGE IN CONFERENCE

REMOVE WALL, WINDOWS AND DOOR TO ENLARGE CONFERENCE ROOM FOR REQUESTED SEATING CAPACITY.

ADD POWER AND DATA FOR COPIER IN THIS EXISTING SPACE

ADD POWER AND WATER SERVICE FOR TWO ADDITIONAL REFRIGERATORS.

REMOVE WALL TO ENLARGE BREAKROOM FOR ADDITIONAL SEATING CAPACITY

RECONFIGURE WALLS TO ADD WELLNESS ROOM WITH ACCESS FROM BREAKROOM

RECONFIGURE WALLS TO RELOCATE IDF ROOM ADJACENT COPY WITH ACCESS TO COMMON HALL

CONVERT EXISTING OFFICE TO ENTRY FOR TRAINING ROOM. POSITION DOORS TO ALLOW FOR A "MEETING HANDOUT" TABLE IN THIS SPACE.

NOTHING IS GAINED BY REMOVING THIS CLOSET SO IT SHOULD REMAIN



Human Services
Administrative Support Division, Facilities

PROJECT: CFS SRD ADMINISTRATION RELOCATION
SAN BERNARDINO, CA

SHEET TITLE: CONCEPTUAL SPACE PLAN, OPTION A,
Revision 2

REVISED: 1 - 10/30/2023 - PER MTG 9/18/23
2 - 1/19/2024 - PER CONV 1/16/23

START DATE: 08/22/2023
DRAWN: D. BUNCH
SHEET NO: 01

EXHIBIT "B-2"
PREMISES DESIGN STANDARDS AND SPECIFICATIONS

**HUMAN SERVICES (COUNTY),
CHILDREN AND FAMILY SERVICES**
SRD Administration

GENERAL GUIDELINES:

This document is intended to be used as a reference for design professionals and a room-by-room list of improvements specific to the project to aid in estimating rough order of magnitude costs.

HUMAN SERVICES acknowledges that Exhibit "A" Premises Design Standards and Specifications sets forth the COUNTY'S design standards and that not all portions of the COUNTY'S design standards will apply to the improvements to be constructed pursuant to the Room-by-Room list in Section 3.0.

Abbreviations:

AP1	-	Acoustical panels
CACB	-	COUNTY approved color board
C1	-	Carpet tiles
P1	-	Low Sheen/Eggshell
P2	-	Low sheen/Eggshell (accent #1)
P3	-	Low sheen/Eggshell (accent #2)
P4	-	Semi-gloss
B2	-	Rubber wall base
VCT	-	Vinyl Composition tile flooring LVT
	-	Luxury vinyl tile (planks)

1.0 CONSTRUCTION GUIDELINES

1.1 CEILINGS:

SUSPENDED CEILING SYSTEMS:

- a. 2' x 4' suspended acoustic ceiling with exposed ceiling tile tee systems, white. Fire rated system in areas required by the applicable Code.
- b. Ceiling height to be ten feet (10'-0"), unless otherwise specified.
- c. Three-fourths inch (3/4") thick Armstrong #1811 Fine Fissured High NRC acoustical ceiling panels, NRC range 0.70, color - white.

1.2 LIGHTING:

- a. 2' x 4' drop-in fixtures unless noted otherwise. Lighting must meet all Building Codes applicable to the building types in this project. All rooms to have separate lighting controls (switches or light sensors).
- b. Lighting fixtures must run parallel of work surfaces or shelving units in storage rooms. All reflected ceiling plans (light fixture locations) must be reviewed and coordinated with the modular furniture vendor and approved by the COUNTY.

EXHIBIT "B-2"
PREMISES DESIGN STANDARDS AND SPECIFICATIONS

- c. Light fixtures in open work areas, offices, lobby, reception, conference rooms, break rooms, and wellness rooms to have lighting controls capable of dimming fixtures to 25% of maximum light output.
- d. Provide additional emergency lighting in all restrooms. If lighting fixtures are utilized for emergency battery back-up lighting purposes, they must be marked by dots (no larger than 1/4") or equivalent for easy identification. Dots must be able to be seen from floor level.
- e. All light switches that control lighting in lobbies or open work area are to be ganged together in the adjacent lobbies or open work areas. No light switches are to be located in areas used by the public.
- f. Lighting controls should be located convenient to the designated employee entrance.
- g. Locations of all light switches are to be approved by COUNTY.
- h. LANDLORD will be responsible for compliance with Title 24 including controlled electrical connection to COUNTY provided system furniture, per applicable energy code/s.

1.3 AIR CONDITIONING:

- a. The facility HVAC system shall be zone controlled with rooms of similar use in each zone to provide an even comfortable temperature throughout the facility as defined by the Mechanical Engineering Standards of ANSI/ASHRAE and SMACNA for duct design unless noted otherwise. COUNTY to approve HVAC zones.
- b. Where existing construction is altered and/or the use of any portion of the building is changed; LANDLORD shall provide testing, adjusting and balancing of the HVAC system to maintain the standard in paragraph 1.3(a).
- c. LANDLORD shall provide the COUNTY with a copy of the air and hydronic balance report from a "third party" firm duly licensed to inspect and certify the performance of the HVAC and other environmental systems.
- d. LANDLORD shall make any adjustments, repairs or replacement of equipment necessary to maintain the standard in paragraph 1.3(a).
- e. Air conditioning supply register: Shall be a two-way adjustable type if near a wall and four-way adjustable if in a room or open area. All registers are to be covered with tamper proof shields. Supply and return registers are to be approved by COUNTY.
- f. All rooms are to have ducted air conditioning supplies and returns. Except the Janitor, IDF and Telephone rooms.
- g. All main heating and air conditioning temperature controls shall be hard wired and placed in electrical room with hard wired remote sensors placed in locations not accessible to tampering. All control locations are to be approved by COUNTY.
- h. Air conditioning requirements for the Telephone/Data Room are included in ITD Telecommunications Spaces Section 2.0.

1.4 CEILING FANS:

- a. Ceiling fans are to be installed as noted on the floor plans and/or listed in the Room- by-Room Section 3.0.
- b. Fans are to be all white, 52", 5 blades, three speeds, no lights and utilize in-wall controls. Acceptable manufacturer: Hunter Fan Company or COUNTY approved equal.
- c. Fan blades to be minimum of eight feet above finish floor unless otherwise approved by COUNTY.
- d. Fan controls shall be installed near lighting controls or convenient to the fan.

EXHIBIT "B-2"
PREMISES DESIGN STANDARDS AND SPECIFICATIONS

1.5 WINDOW COVERINGS:

- a. LANDLORD to provide window coverings at all windows unless otherwise noted or approved by COUNTY.
- b. Window coverings to be roller shade type providing solar insulation to reduce glare and heat gain. Type to be consistent throughout facility. Product, material, and design to be approved by COUNTY. Acceptable manufacturer: Mecho, www.mechoshade.com, or COUNTY approved equal.
- c. Window shade installation should provide full coverage of the glass surface

1.6 WALL CONSTRUCTION:

INTERIOR WALLS:

- a. The interior sides of all concrete or block walls are to be furred with a textured drywall finish, unless otherwise noted and approved by COUNTY.
- b. All interior walls shall be constructed to 4" above ceiling, at a minimum, unless otherwise noted and approved by COUNTY.
- c. All interior walls shall be finished with textured drywall, both sides, unless otherwise noted and approved by COUNTY.

INSULATION/SOUNDPROOFING:

- d. All wall cavities around hallways, restrooms, private offices, breakrooms; meeting/conference rooms, lobby areas and any special areas as specified by COUNTY shall be completely filled with insulation to help reduce sound transmission.
- e. If walls in these areas do not extend above T-bar, sound tape must be installed between finished ceiling and top wall track.

BACKING FOR ELECTRONIC EQUIPMENT:

- f. Walls in conference rooms, lobbies and some offices may need backing for wall-mounted TV monitors. Refer to Room-by-Room Section 3.0 for additional information.

1.7 WALL FINISHES:

TILE:

- a. See "RESTROOM FACILITIES" section or as noted on the floor plans and/or listed in the Room-by-Room Section 3.0.

PAINT:

- b. All interior walls shall be orange peel textured with one coat of primer. Apply color topcoats needed to match the selected color chip provided by manufacturer, with a minimum of two coats of paint, the final coat rolled on for a smooth finish.
- c. Acceptable manufacturers: Dulux, Sinclair, or Dunn-Edwards.
- d. Paint colors (P1) Low sheen/Eggshell, (P2) Low sheen/Eggshell accent, (P3) Low

EXHIBIT "B-2"
PREMISES DESIGN STANDARDS AND SPECIFICATIONS

sheen/Eggshell accent and (P4) Semi-gloss to be approved by COUNTY. Placement of accent P2, P3 and Semi-gloss P4 within the facility to be approved by COUNTY. All other painted walls will be P1.

- e. "Drawdowns" of selected paint colors to be provided prior to commencing work.

1.8 NOT USED:

1.9 NOT USED:

1.10 FLOORING:

GENERAL:

- a. All slabs/subfloors to be prepared per manufacturer's recommendations and such that all areas are level, smooth and free of debris.
- b. All flooring to be installed per manufacturer's recommendations and as applicable to maintain warranty.
- c. Moisture testing of concrete slabs is required prior to start of work.
- d. LANDLORD to comply with all applicable laws/regulations regarding asbestos testing.

CARPET:

- e. High-density carpet squares (C1). Manufacturer, type, color and placement in facility to be approved by COUNTY. The COUNTY is requesting when able to move toward a no VOC carpet installation whenever possible.
- f. Installation to be as per manufacturer recommendations, using only manufacturer's approved adhesives and seam sealers as needed and as applicable to maintain manufacturer's warranty.
- g. Rubber base to be installed in all carpeted areas. Manufacturer, type, color and placement in facility to be approved by COUNTY. Installation to be as per manufacturer recommendations.

VINYL FLOOR:

- h. Manufacturer, type, color and placement to be approved by COUNTY. COUNTY to designate vinyl floor selection and room location. Armstrong Exelon vinyl tile (VCT) 1/8" gauge, 12" x 12" with 4" rubber wall base. Manufacturer, type, color and placement to be approved by COUNTY.
- i. Vinyl planking manufacturer, type, color and placement to be approved by COUNTY.
- j. Welded seam manufacturer, type, color and placement to be approved by COUNTY.

PORCELAIN OR CERAMIC FLOOR TILE:

- k. Not Applicable

EXHIBIT "B-2"
PREMISES DESIGN STANDARDS AND SPECIFICATIONS

WALK-OFF FLOORING:

- I. Not Applicable

1.14 SIGNAGE:

INTERIOR:

- a. LANDLORD shall provide all Code required signs including, but not limited to, ADA, emergency evacuation and directional interior signage. COUNTY to approve wayfinding signage.
- b. Wayfinding signage to be coordinated with COUNTY and provided for Public areas (i.e. Lobbies).
- c. Room numbers to be provided and coordinated with COUNTY.

EXTERIOR:

- a. If exterior signage/monuments are present COUNTY has first right of refusal/approval to use as representing the COUNTY. LANDLORD will be responsible for design modifications, permits, fees and/or removal disposal costs.
- b. LANDLORD will provide exterior premises signage, as consistent with adjacent building/businesses, if applicable, and as approved by COUNTY.
- c. Raised, non-illuminated letters, monument type on stand-alone buildings, per City regulation and COUNTY approval.
- d. LANDLORD to provide building signage to have address and logo, COUNTY to approve logo design, (COUNTY to provide approved County branding/logo information packet).
- e. LANDLORD to provide entry door lettering: County name, agency name, and hours of operation and County "No Smoking" verbiage as allowed by jurisdiction and COUNTY approved.

1.15 CABINETRY:

- a. Unless otherwise noted, all exterior surfaces are to be of high-pressure laminate. All countertops to be of solid surface and/or high-pressure laminate with finished edges. If using high-pressure laminate materials the seams shall be placed and installed away from all water sources. Material and colors and shop drawings are to be approved by COUNTY prior to manufacturing.
- b. The inside of cabinets and drawers are to be completely lined with thermal fused material white in color.
- c. Unless otherwise noted, adjustable shelves in all cabinets, $\frac{3}{4}$ " stock, thermal fused laminate material installed on all sides.
- d. Where water is present, countertop edges are to be elevated bull-nose or V-cap, with flat end trim. Counters in open areas must have rounded (radiused) corners.
- e. Heavy-duty hinges on all lower cabinets.
- f. ADA hardware on all cabinetry.
- g. 4" toe kick on all lower cabinets, unless prohibited by ADA requirements.

EXHIBIT "B-2"
PREMISES DESIGN STANDARDS AND SPECIFICATIONS

1.16 EMPLOYEE BREAKROOM/ CONFERENCE ROOM COFFEE BAR:

- a. Over-counter storage cabinets and under-counter storage cabinets and drawers with counter top per Section 1.15. Design and materials to be COUNTY approved.
- b. Counter top to be 34" finished height. Design and materials to be COUNTY approved.
- c. Soap and paper towel dispensers installed convenient to each sink and paper towel dispensers at each microwave, locations to be approved by COUNTY. Dispensers set at location and height to accommodate ADA requirements.
- d. Stainless steel double bowl sink, 36" wide, minimum of 8 ½" deep or at ADA requirements.
- e. ADA approved faucet set, deck mount, gooseneck spigot, stainless steel or chrome finish, washerless. Delta or COUNTY approved equal.
- f. Garbage disposal, minimum ½ h.p, In-Sink Erator or COUNTY approved equal.
- g. Water heater: Tankless, electric, under-counter. Set at 110 degrees, with a recirculating hot water loop to eliminate hot water wait times. Provide and install as needed to heat water at sinks and coffee station. COUNTY to approve selection.
- h. Space for 21 C.F. refrigerators with icemakers. See Room by Room Section 3.0 for quantities and project specific information. Plumbing connection for icemaker shall be recessed into wall, one per refrigerator.
- i. Space on counter top for 1 ½ C.F. microwave ovens. See Room by Room Section 3.0 for quantities and project specific information.
- j. All water line connections from recessed valves to refrigerators and/ or coffee stations must be made by LANDLORD and deemed operational.
- k. All break rooms shall be designed to minimize the migration of food/cooking smells into the general open work areas. Designs to include the segregation of the break areas into the more utility portions of the building and separately zoning the AC as to not carry odors into other areas, and placing high-volume, quiet exhaust fan/s inside the room at the door exiting into the work area, wiring the fan to the lighting for continual operation.
- l. Each appliance (i.e. microwave, coffee pot, toaster) shall have a dedicated circuit. See Room by Room Section 3.0 for quantities and project specific information.

1.17 DOORS AND DOOR HARDWARE:

- a. All door schedules and door hardware to be approved by COUNTY.
- b. All interior doors to be solid core wood. Acceptable manufacturer: Haley Bros. Color and finish to be approved by COUNTY.
- c. Schlage Heavy-Duty locksets are required and all lock functions are to be COUNTY approved, unless otherwise specified.
- d. Von Duprin 99 L-RH (LH for left side handle) 36" push bar panic device, 2060 finish shall be installed at all required panic bars locations. The Von Duprin electronic break away outer trim (L996E) shall be used with all panic devices prepared for the COUNTY card access system unless otherwise specified (see Figure 2). All other interior doors to have the Securitron UNL-24 electronic strike installed in the door frame where County card access is required. County will connect these card access components with a COUNTY approved vendor to a County owned card access system.
- e. Any interior or exterior door utilizing COUNTY installed card-access system must have

EXHIBIT "B-2"
PREMISES DESIGN STANDARDS AND SPECIFICATIONS

installed at the door: data boxes - one in wall @ 42" from floor and one in ceiling above door for all proximity card readers; door closers; storeroom function locksets and fail-secure outer trim. See drawing for required conduit runs and data box installation locations (Figure 1).

- f. Push plates and pull handles instead of doorknobs or lever handles on rest room entrance doors, except for single occupant restrooms, or as described on the room- by-room specifications or as allowed by applicable code.
- g. Occupancy indicator hardware at single occupant restrooms.
- h. All lockable doors must be pinned using a Grand Master hierarchy. COUNTY to approve all sub masters and change keys. A copy of the pinning charts must be submitted to the COUNTY with the keys for the facility.
- i. All hardware must meet or exceed all applicable codes and ADA requirements.
- j. All exterior doors that lead into the lobby, hallways or any other work areas shall have a solid, waterproof overhead canopy extending at least 3 feet from the door with a width that covers the entire entrance area with overhead lighting below the canopy and above door.
- k. Door scope viewer: minimum 200 degree viewing angle. Install at all exterior employee entrance/exit doors. COUNTY to approve selection.
- l. Closers: to be installed at exterior doors and doors with card access system. Locations to be approved by COUNTY.
- m. Entrance: storefront doors preferred at main entrance. One for ingress, one for egress and coordinated with the security check procedure as required. COUNTY to approve design.

1.18 RESTROOM FACILITIES:

COMMUNITY RESTROOMS:

- a. Existing community restrooms to be ADA compliant. Installation of all components, fixtures and signage must comply with all applicable health, safety, and ADA codes.
- b. Diaper changing tables: Provide and install, per all manufacturers' guidelines, in each public restroom: Diaper Deck manufactured by American Infant Care Products, Koala, Rubbermaid Commercial line, or COUNTY approved equal.
- c. All restrooms to have emergency back-up lights, COUNTY to approve design and manufacturer.

1.19 DRINKING FOUNTAIN:

- a. One (1) wall mounted filtered cooler per floor, installed within manufacturer's and ADA guidelines.
- b. Acceptable manufacturer: Elkay. COUNTY to approve model.
- c. LANDLORD is responsible for filter maintenance.

1.20 STORAGE:

- a. Not Applicable

1.21 ELECTRICAL:

- a. LANDLORD is responsible for all electrical connections from modular furniture systems to receptacle outlets as required per furniture plans and in compliance with title 24.

EXHIBIT "B-2"
PREMISES DESIGN STANDARDS AND SPECIFICATIONS

- b. Large open work areas to have electrical "J" boxes above ceiling for modular furniture power pole connection. The COUNTY requires a minimum of a 3:1 ratio, three (3) cubicles per one (1) electrical 20 amp circuit. COUNTY will provide final furniture plan with total "J" boxes and circuits needed.
- c. When a TV monitor/AV Display is specified, provide two electrical and data outlets (high and low).
- d. COUNTY to approve all data/phone and duplex locations.

1.22 DATA ROOMS, CABLING AND EQUIPMENT:

Specifications are included in Section 2.0 and as shown on plans for the Data/IDF rooms.

- a. Data outlets to be provided for workstations, copiers, fax machines, AV displays, card reader access system, surveillance system and any other areas specified on plans or in Section 3.0, Room by Room Improvements.
- b. LANDLORD to provide 1 inch conduit, with pull strings, stubbed out above the ceiling at all data outlet locations. If the ceiling is not accessible for pulling cable, the conduit must home run to the nearest IDF location.
- c. LANDLORD to install blank covers over all unused telephone/data outlets.
- d. Telephone and data equipment, lines, and jacks to be installed by COUNTY.

1.23 NOT USED

1.24 EXTERIOR REFUSE:

- a. Dumpster enclosure construction to be concrete block for walls with swinging metal gates and cover to minimize vandalism and illegal dumping. one (1) dumpster to be designated for recycling. Design and location of enclosure to be approved by COUNTY and must meet all applicable code requirements.
- b. At entrance/exit areas, LANDLORD to provide secure tamper-resistant trash receptacles (concrete) with plastic liner and attached lids. Location and style to be approved by COUNTY.
- c. At employee entrance/exit areas, LANDLORD to provide ash urns (concrete) filled with silica sand. Location and style to be approved by COUNTY.

1.25 MAILBOX:

- a. The LANDLORD is responsible for providing and installing a properly identified US mailbox outside the building that will meet United States Postal Service requirements. Location must be approved by the local Postmaster to ensure delivery of mail to this COUNTY facility. COUNTY to approve size of mailbox.

1.26 NOT USED

1.27 FIRE ALARM:

- a. Fire alarm system to be installed at LANDLORD expense with all necessary components to meet all applicable codes.

EXHIBIT "B-2"
PREMISES DESIGN STANDARDS AND SPECIFICATIONS

- b. COUNTY to approve location of main fire alarm control panel.

1.28 FLAGPOLE:

- a. LANDLORD to provide an exposed height pole to the highest allowable as permitted by local codes and regulations.
- b. Cast aluminum pole.
- c. External single halyard with revolving cast aluminum halyard truck.
- d. Cast aluminum cleat enclosed in an opening, lockable box or other tamperproof arrangement for securing the halyard.
- e. Lighting for the flags to be mounted on building or parking lot pole in accordance with all applicable codes and regulations.

1.29 PLAN COPIES and REVIEW SETS

LANDLORD to provide to COUNTY:

- a. Two (2) sets of hardcopies and one (1) electronic set (.pdf format) of approved/permitted construction plans prior to commencing construction.
- b. One (1) electronic CAD copy of the same plans in .dwg format at completion of working drawings.
- c. One (1) As-Built set of permitted drawings in .pdf format and one (1) set of red line drawings with building changes noted in red pen, over an approved set of plans; attach Change Orders and Addendum's that reflect the Tenant Improvements only, delivered to the COUNTY within 60 days of completion of project.
- d. One reproducible color copy of egress plan reduced to fit an 8.5" x 11" picture frame.
- e. One (1) Design Review Set (.pdf format and hardcopy) at completion of Design Development. COUNTY to approve Final Design prior to proceeding with construction documents.
- f. One (1) Progress Set (.pdf format and hardcopy) at 50% completion of construction documents.
- g. One (1) Progress Set (.pdf format and hardcopy) at 90% completion of construction documents prior to Plan Check submittal.

1.30 LANDSCAPING

- a. LANDLORD to supply, install and maintain landscaping appropriate to the local flora or approved by local city. Design of landscaping near building entrances shall not provide intruders an area of concealment.
- b. LANDLORD shall maintain all floras to thrive and maintain an attractive appearance at all times.
- c. LANDLORD to keep landscape areas weed and debris free at all times.

1.31 EXTERIOR PARKING

- a. LANDLORD to provide parking in accordance to all applicable codes/ordinances.
- b. LANDLORD to provide 60 parking spaces, non-dedicated, with accessibility to ADA parking.
- c. LANDLORD to provide loading areas and "facilities" parking per approved conceptual plans and as listed in Room by Room Section 3.0.

EXHIBIT "B-2"
PREMISES DESIGN STANDARDS AND SPECIFICATIONS

1.32 WINDOWS

- a. In new construction, LANDLORD shall design exterior building windows such that h office areas, conference rooms and any other appropriate interior areas receive as much natural ambient light as possible.
- b. Windows at private offices shall have sill heights above typical desk work surfaces and have a maximum width of 36 inches, when possible unless noted otherwise and approved by COUNTY. Sizes of windows in all other rooms and areas to be determined by architect and approved by COUNTY.
- c. All exterior elevation designs for new construction or tenant improvements to existing structures will need to be designed by the LANDLORD'S architect and structural engineer and approved by COUNTY.

1.33 SECURITY

SURVEILLANCE SYSTEM:

- a. When specified in the Room by Room Section 3.0, LANDLORD to provide conduit as necessary to support the surveillance system (installed by others) for the premises.
- b. Surveillance system (designed by others) to include but not limited to video cameras in parking lot, at building entrances/exits and County vehicle secured parking gates.
- c. LANDLORD to provide additional conduit at specified doors to support entrance/exit alarms in connection with the surveillance system.

2.0 INNOVATION AND TECHNOLOGY COUNTY (ITD) TELECOMMUNICATIONS SPACES

2.1 TELECOMMUNICATION SPACES DRAWINGS:

The San Bernardino County Department of Innovation and Technology (ITD) will provide plan and elevation drawings for each telecommunication space specific to the Human Services COUNTY (COUNTY/COUNTY) projects. Drawings must show critical equipment and connectivity: Cabinets and racks, cable management, cable pathways, patch panels, shelving, bonding (grounding), other facility systems if needed. Drawing will indicate access provider (telco services) within the room, security alarm system panels and door access control panels. All power receptacle types including voltage/amperage output will also be indicated on the communication MDF / IDF drawings.

2.2 TELECOMMUNICATION SPACES DIMENSIONS AND LOCATIONS:

The Equipment room (MDF) shall be a minimum of 12 ft. by 14 ft. in dimension and the Telecommunication room (IDF), if required, shall be a minimum of 10 feet by 10 feet. The Equipment rooms (MDF) should be centrally located on a given floor within the proposed building to support a maximum 295 ft. cable run. Do not use other equivalent area within the building to substitute for this specified location. Equipment rooms (MDF's) are positioned so cable runs exceeding 295 ft. will require a separate communication Telecommunication room (IDF) room. The telecommunication spaces are to be used exclusively for County ICT Telecommunications/Data and COUNTY controlled systems equipment only. No building systems such as fire alarm, HVAC equipment or other services shall be placed in this room. An emergency battery backup light device shall be

EXHIBIT "B-2"
PREMISES DESIGN STANDARDS AND SPECIFICATIONS

installed above the room entrance door. Telecommunication spaces electrical power, flooring, grounding, and backboards shall be completed well in advance of building completion to facilitate the COUNTY communications and security support required to protect COUNTY assets during the building project.

2.3 POWER AND ELECTRICAL OUTLETS:

- a. The main Telephone/Data/Communication room (MDF) shall have an independent 24 position, 100/200 Amp, 120/208, three phase, four wire, surface mounted, sub- panel with a White Neutral buss bar, and an Isolated Green Ground buss bar inside. The normal size sub-panel in the room for the majority of the locations will be specified at 100 Amp capabilities unless otherwise identified. The grounding screw in the sub panel neutral buss will not be tightened to make contact with the sub-panel frame unless otherwise required by code.
- b. All electrical outlets within the communication rooms shall be dedicated. Voltage/amperage output as well as receptacle type will be indicated on the ISD MDF / IDF drawing. Receptacles will be required to mount on both the walls and the overhead cable trays to support the necessary data and telephone equipment. 20A and 30A twist lock receptacles may be required.
- c. A copper earth ground rod will be required in each communication MDF and IDF installed at a minimum 6 ft. depth. The ISD MDF/IDF COUNTY drawing will indicate the desired location of the rod. ISD will provide and install a multi-position buss bar when building out the communication rooms.

2.4 BACKBOARDS:

All walls within the MDF / IDF rooms shall be covered in ¾" fire rated plywood with the fire rating stamp in plain view. If painted plywood is requested for the project, fire rating stamps are to be left uncovered as indicated by local building code.

2.5 FIRE SPRINKLERS:

If a fire sprinkler system is required in a building, having Telephone/Data rooms/Microwave Radio Rooms, the sprinklers shall be a high temperature standard response with a 360 Degree coverage head, with heavy-duty safety cage.

2.6 AIR CONDITIONING:

- a. The heat load within the Telephone/Data/Microwave-Radio Rooms will vary directly with the installation of the type and quantity of active electronic equipment to be placed there. If an individual is assigned and positioned there, additional BTU per person should be added to the calculations. The room's air-conditioning should be designed to handle the equipment load in addition to normal construction heat load designs. Once the total heat load requirements are calculated and the air conditioner size is selected, an additional matching redundant air conditioning unit will be required and electronically controlled by the room controls. The electronic controls shall include a "Lead-Lag" system, programmed to alternate the lead starting unit with the two independent air conditioning units. The COUNTY shall approve the set-up temperature settings and the time frames for the "Lead-Lag" programs and the condensate water path from any of the installed air conditioning

EXHIBIT "B-2"
PREMISES DESIGN STANDARDS AND SPECIFICATIONS

units. If using fan coil above the ceiling the units are required to be installed in the hallway adjacent to these rooms away from the cable rack/trays installed in these rooms.

- b. The electronic equipment and backup battery plant requires a normal operating temperature of 77 degrees Fahrenheit with a relative humidity range of 30 % to 55%, and must be controlled by a thermostat within the room. The room air-conditioning units may require a heat pump depending on the elevation above sea level such as in remote mountain locations. This air-conditioning system should be installed as a stand-alone system and not a part of the building air-conditioning system. This system is required to be available for operation on a 24-7 basis. The BTU heat loading for equipment and personnel can be computed as follows:
- 12,000 BTU (British Thermal Units) equals one ton of Air Conditioning.
 - Allow 400 BTU for each person assigned to work permanently in the room as applies.
 - If you know the wattage usage of the electrical/electronic equipment, multiply the Watts/Hr. times 3.409 to obtain BTU.

2.7 FLOOR COVERING:

The floor shall be covered with dust sealed vinyl composition tile (VCT)

2.8 DOOR:

- a. The Telecommunication spaces doors shall be no less than 36 inches (3ft.) wide with standard height. These doors shall be keyed separately from the doors in the rest of the building and/or have a secured COUNTY card access installed. If it is expected that large equipment will be delivered, a double door (6ft) wide should be provided. All doors shall have access control.
- b. Door sweeps should be considered instead of thresholds. Doors shall be the same fire rating as the room.
- c. Access should allow for future equipment changes.
- d. Double Doors may require removable center posts. Where doors cannot be opened completely, they should be removable.
- e. Note: Doors that open outward provide additional space and reduce constraints on telecom spaces layout but are sometimes prohibited by building codes.

2.9 LIGHTING:

Telecommunication spaces shall be coordinated to have the lighting layout with the telecommunication equipment such as racks, overhead ladder cable tray to ensure that lighting is not obstructed. Coordinate lighting positions according to the ITD telecom space drawings provided. Locating light fixtures a minimum of 8.5 ft AFF when possible. Provide a minimum of 500lx (46 foot-candles) of lighting in the horizontal plane and 200lx (18.6 foot-candles) in the vertical plane, measured (3.28 ft) above the finished floor in the middle of all aisles between cabinets and racks.

2.10 WEATHER SEAL:

All exterior MDF/IDF doors shall be weather sealed on all sides including the threshold.

EXHIBIT "B-2"
PREMISES DESIGN STANDARDS AND SPECIFICATIONS

2.11 TELCO REQUIREMENTS (AT&T, Frontier Communications, Spectrum):

For locations where Telco's MPOE (Minimum Point of Entry) or Demarcation

Point is separate from the buildings MDF; a 4 ft. by 8 ft. backboard space will be required in order to land their fiber and or copper terminals. The backboard shall be

$\frac{3}{4}$ " fire rated plywood with the fire rating stamp in plain view. No paint will be required for this backboard. In addition to the backboard, a ground buss bar or ground rod will be required at the MPOE location in order to ground the Telco terminals. A total of (1) duplex NEMA 5-20R electrical outlet will be require in the MPOE to support any required Telco equipment (NID, UPS etc.).

2.12 TELCO ENTRANCE CONDUITS:

Provide (2) – 4 inch PVC conduits between the Telco MPOE and the approved Telco entrance vault location. The Telco entrance vault location is to be determined by the Telco provider. ISD is not allowed to locate the entrance vault for Telco service; it is to be strictly coordinated between the LANDLORD, architect and the Telco provider during the design phase of the project.

2.12 TELCO INTERIOR CONDUITS:

Locations that have a separate MPOE and MDF will require a 2 inch, homerun conduit between the two rooms. Conduit runs will require sweeps equal to no less than 10 times the diameter of the conduit. Pull boxes will be required in conduit runs where more than (2) 90 degree sweeps are present and conduit runs that exceed 100 feet in length. Pull boxes in conduit runs should be no less than 18 inch by 18 inch by 6 inch in size. Plastic bushings are required on rough conduit ends. Pull rope or mule tape is required in all homerun conduits.

2.13 MDF TO IDF CONDUITS:

MDF to IDF conduits will only be required in hard lid ceiling environments. When a hard lid ceiling is present between the MDF and IDF, (1) – 4 inch PVC or EMT conduit will be required to tie the two rooms together. Conduit runs with more than two 90 degree sweeps will require an 18 inch by 18 inch by 6 inch pull box in the conduit run located in an accessible ceiling area. Additional pull boxes may be necessary depending on the total number of 90 degree sweeps contained within the conduit run.

2.14 OFFICE AND WORKSTATION CONDUITS:

All Telephone/Data wall jack locations installed within room walls shall have $\frac{3}{4}$ -inch EMT conduit connected to a 2s/4s wall box at standard outlet elevation, stubbed off 6 inches above the drop ceiling. Each conduit will require a plastic bushing on the rough end. Where modular furniture is to be installed in an office, coordination for conduit placement is required.

2.15 INTER FLOOR CONDUITS:

- a. In buildings where IDF rooms are stacked one above the other, there shall be a minimum

EXHIBIT "B-2"
PREMISES DESIGN STANDARDS AND SPECIFICATIONS

of two (2) each 4-inch diameter schedule 40 PVC gray conduits through the ceiling of the room below and the room above. These conduits will extend into the rooms at least three inches below drop ceilings and three inches above floor level.

- b. In buildings where IDF rooms are not planned to be above one another, these two 4- inch conduits shall be contiguous runs with pull ropes. In this event minimum bend radius shall be 40 inches minimum. Conduit runs exceeding 100 feet or have more than two 90 degree bends are to have 18" x 18" x 6" pull boxes installed.

2.16 CONDUIT SLEEVES:

The Telephone/Data room shall have a minimum of Four (4) each EMT conduit sleeves Extending above the drop ceiling for cable access or as noted on the ISD MDF/IDF COUNTY drawings. Each sleeve shall extend 5" on either side of the ceiling. All conduit sleeves require plastic bushings at both ends

2.17 BUILDING INTERCONNECT:

Conduits used between buildings shall be 4-inch minimum diameter using schedule 40 gray PVC. Bends within 10 feet of each building shall be 48-inch/45 degrees and midpoint bends shall be a minimum of 72-inch radius.

2.18 FIRE WALLS:

Conduit sleeves through firewalls, block, or concrete walls connecting units within a building or to adjacent buildings shall use either 3-inch or 4-inch I.D. Gray PVC Conduit, unless otherwise specified by code. These sleeves will extend 5-inches on either side of the wall and will be made fire safe after the cabling has been passed through.

2.19 EARTHQUAKE BRACING:

Earthquake bracing of equipment cabinets and data racks will be provided by the Information Services COUNTY/COUNTY.

2.20 APPROVAL:

The COUNTY/ISD, and Network Services Division must approve any exceptions or modifications to these specifications. Any questions regarding these specifications should be directed to the Telecommunications Engineering Section at 909-388-5513 or the COUNTY HS Project Manager.

EXHIBIT "B-2"
PREMISES DESIGN STANDARDS AND SPECIFICATIONS

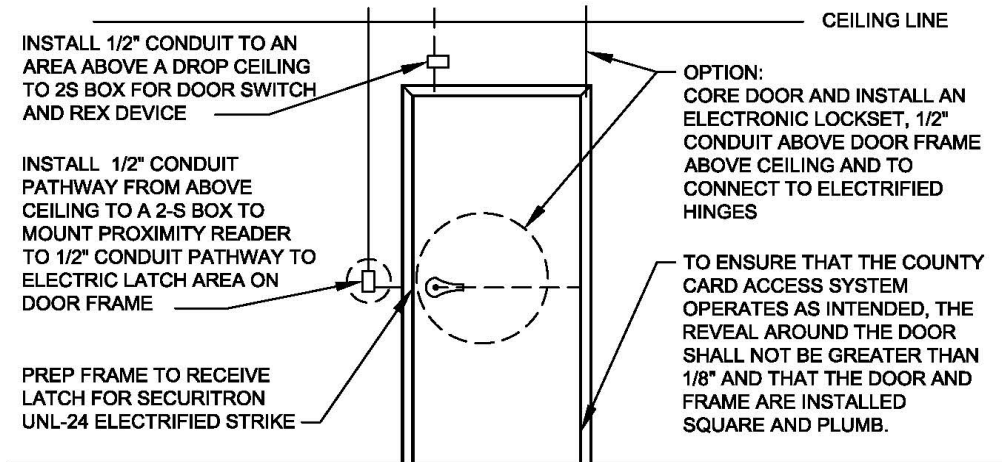

TYPICAL INTERIOR CARD ACCESS DOOR

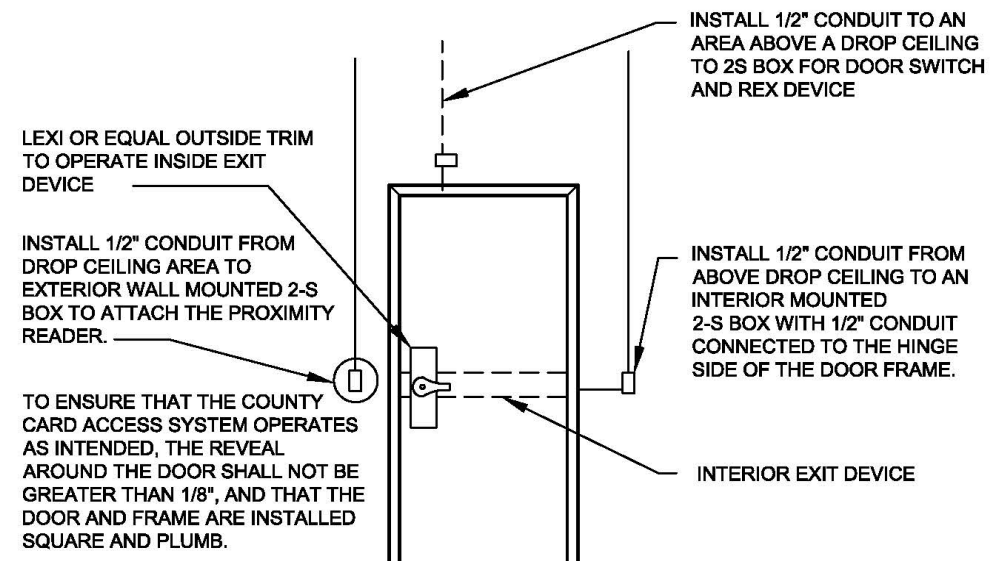

TYPICAL EXTERIOR CARD ACCESS DOOR

EXHIBIT "B-2"

PREMISES DESIGN STANDARDS AND SPECIFICATIONS

Figure 1 - Typical card access door installation guidelines.

VON DUPRIN. E996L Electrified Breakaway™ Lever Trim

E996L electrified Breakaway lever trim provides remote locking and unlocking capabilities while incorporating the patented Breakaway trim design.

The 24VDC solenoid can be energized from a distant controller, thus allowing access control of the opening. The control of stairwells in high-rise buildings is a common application for this trim.

When electrically unlocked the unit operates as a normal lever trim. When electrically locked, the lever feels locked, but when more than 35 pounds of torque pressure is applied, the Breakaway lever feature engages.

The E996L is provided standard in a fail safe (FS) condition, but can be field converted to a fail secure (FSE) where allowed. The trim can be ordered with a device, added to an existing 98/99 series device application, or a conversion kit can be added to an existing 996L Breakaway lever trim. On new construction applications, the E996L trim will require less door prep.

The E996L is available with a blank escutcheon (BE) function, or with a cylinder for night latch function.

The E996L electrified trim replaces the current "E" electric feature on 98/99 series rim devices. Consult factory for requirements.

To Order, Specify:

1. Use "E" prefix, example E996L.
When ordering with device specify trim series with "E" prefix, example 9927/L-BE 3' US26D E996.
2. Device type, R/V (rim/surface or concealed vertical rod) or M (mortise).
3. RHR is furnished standard if not specified.
Field reversible.
4. Lever style (06 lever is furnished standard).
5. Finish: US3, US4, US10, US10B, SP313, US26, US26D, SPBLK, US15



SPECIFICATIONS
Solenoid – Continuous Duty 24VDC
Solenoid Draw – 0.22 amp

E996L ELECTRICAL WIRING

- Power input for E996L is 24VDC
- Two wires on trim are non-polarized (18 AWG minimum)

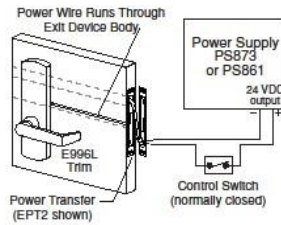

LEVER DESIGN OPTIONS



EXHIBIT "B-2"
PREMISES DESIGN STANDARDS AND SPECIFICATIONS

Figure 2 - Von Duprin cut sheet

SHELF UNIT SPECIFICATIONS

NOTE: Shelving 3/4" thick
Enclosed back 1/4" wood

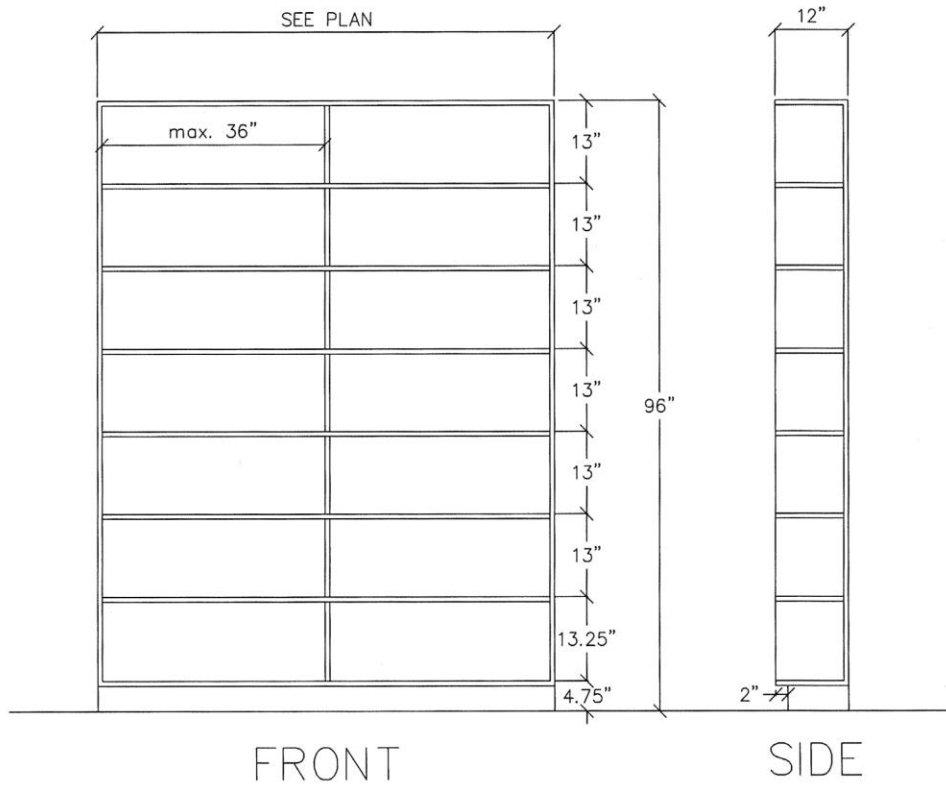



EXHIBIT "B-2"
PREMISES DESIGN STANDARDS AND SPECIFICATIONS

Figure 3 - Shelving Unit specifications

EASY INSTALLATION







Step 1: Snap "Starter Edge" into the up-rail of the steel flange.



NOTE: Start with the first full bay. Use standard 4" Timbers for off-rails & bays.



Fit Danback flexible wood backing around steel flange using 4" flexible connector plate.



Repeat the process.





Overlap connector plates when coming into an ending bay.



Secure each plate to the steel flange using 2 small 3/8" x 1 1/2" head screws.

Danback® is available in standard 4x8, 4x12 & 4x16 sizes. Connector Plates included with Timbers.

Fast Snap, Fire and Screw: reduces backing installation time up to 90%, it's that fast!

Backing steel studs has always been a difficult, costly and time-consuming job. The Danback® Flexible Wood Backing System, featuring **DRICON®** fire-resistant treated wood, has made wood backing installation easy and economical.

Danback® is a heavy-duty flexible wood backing system used to support cabinets, shelves, handrails, wall mounted sinks and counters and all other wall-mounted fixtures. Danback® provides superior connection shear and pull-out strength to support and resist even some of the heaviest loading conditions. Simply snap, fire and screw. Just a few minutes. The patented hinge design actually fits around the stud and snaps into place for a perfect fit - every time.

Danback® is constructed using **DRICON®** fire-resistant treated wood (FRT). **DRICON® FRT** is pressure-treated wood that is chemically treated to reduce the flame spread and smoke development. **DRICON®** is a Class A fire retardant, that is CPW certified, NFPA approved (NFPA-303) and complies with all national codes including the 2003 International Building Code (IBC) and the 2003 International Residential Code (IRC).

DRICON® FRT wood complies with or has been granted the following:

ANSI C119 ASTM F2133-02 F15 ICC-ES ESR-1107 ICC-ES ESR-1108 ICC-ES ESR-1109 ICC-ES ESR-1110 ICC-ES ESR-1111	All recognized countries BPC 1916-1043-01 BPC 1916-1043-02 BPC 1916-1043-03 BPC 1916-1043-04 BPC 1916-1043-05 BPC 1916-1043-06 BPC 1916-1043-07	EBC Wood Backing (EBC) California Fire Standard NFPA 303, 308 CP CPW ICC-ES ESR-1107 ICC-ES ESR-1108 ICC-ES ESR-1109 ICC-ES ESR-1110 ICC-ES ESR-1111
--	--	---

Use Danback® timbers in off-module bays.



Call for required length. Screen to determine size to the framed edge. Position the plate to Danback using 3/8" x 1 1/2" screws or other fire-rated screws.







Figure 4 - Dietrich Backing

EXHIBIT "B-2"
PREMISES DESIGN STANDARDS AND SPECIFICATIONS

JUST SNAP, FLEX and SCREW

Reduce steel stud backing installation time up to 90%. It's that fast!



The Perfect Backing Solution for:



Commonly Used in:

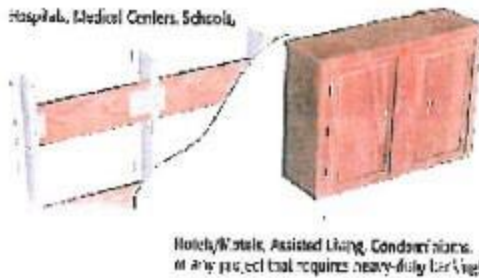

Features and Benefits:

- Reduces installation time up to 90%
- Available for 16" and 24" O.C. framing
- Eliminates cutting, notching, ripping and sewing
- Made with Dricoat® fire-retardant treated wood

- Complies with all national building codes
- PPA registered protection against termites and fungal decay
- No greater corrosion rates than untreated wood

Product Specifications and Packaging

Part	Width	Length	Weight/Box	Packaging	
Product Code	in.	mm	lbs.	kg	
D16F	5-1/2"	120"	2,174	2,315	540
D24F	5-7/8"	120"	2,174	2,315	540

© 2010 Dietrich Metal Framing, Inc. All rights reserved.
This document is the property of Dietrich Metal Framing, Inc.

Ultimate Load Value

C.O.T. Product Code	Shear Load Max. lbs.	Norm. Load Vert. lbs.
D16F	200	500
D24F	175	438

NOTE: Load values are maximum per stud. Load values represent static loads only. Factors appropriate for seismic and other loads should be used. See the 2010 International Building Code for details.

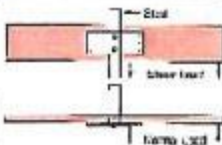

© 2010 Dietrich Metal Framing, Inc.
Dietrich Metal Framing is a registered trademark of Dietrich Metal Framing, Inc.
www.dmf.com

request a quote **online** @ dietrichmetalframing.com or **call 1-866-638-1908**

Our customer rarely thinks to fully test Dietrich's construction medical center. They used additional wood backing methods on the 16" floor and 24" counter tops. We introduced them to "Dricoat" and on the second day, saw removal of backing, it took the same 3 men 3 hours!

Randy Yonnis
S&B Supply Greens Bay



Figure 5 - Dietrich Backing cont'd

EXHIBIT "B-2"
PREMISES DESIGN STANDARDS AND SPECIFICATIONS



Elkay Enhanced EZH2O Bottle Filling Station & Single ADA Cooler
Filtered 8 GPH Stainless
Model LZS8WSSP

PRODUCT SPECIFICATIONS

Elkay Enhanced ezH2O® Bottle Filling Station & Single ADA Cooler, Filtered 8 GPH Stainless. Chilling Capacity of 8.0 GPH (gallons per hour) of 50° F drinking water, based on 80° F inlet water and 90° F ambient, per ASHRAE 18 testing. Features shall include Hands Free, Visual Filter Monitor, Automatic Filter Status Reset, Filtered, Energy Savings, Green Ticker™, Laminar Flow, Antimicrobial, Real Drain. Furnished with Flexi-Guard® Safety Bubbler. Electronic Bottle Filler Sensor With Electronic Front And Side Bubbler Pushbar activation. Product shall be Wall Mount (On Wall), for Indoor applications, serving 1 station(s). Unit shall be certified to UL 399 and CAN/CSA C22.2 No. 120. Unit shall be lead-free design which is certified to NSF/ANSI 81 & 372 (lead free) and meets Federal and State low-lead requirements.



Special Features:	Hands Free, Visual Filter Monitor, Automatic Filter Status Reset, Filtered, Energy Savings, Green Ticker™, Laminar Flow, Antimicrobial, Real Drain
Finish:	Stainless Steel
Power:	115V/60Hz
Bubbler Style:	Flexi-Guard® Safety Bubbler
Activation by:	Electronic Bottle Filler Sensor With Electronic Front And Side Bubbler Pushbar
Mounting Type:	Wall Mount (On Wall)
Chilling Option*:	8.0 GPH
Full Load Amps	5
Rated Watts:	370
Dimensions (L x W x H):	18-3/8" x 19" x 39-7/16"
Approx. Shipping Weight:	85 lbs.
Installation Location:	Indoor
No. of Stations Served:	1
*Based on 80° F inlet water & 90° F ambient air temp for 50° F chilled drinking water.	

Special Note: One-Box Packaging.

- Visual Filter Monitor: LED Filter Status Indicator for when filter change is necessary.
- Filter is certified to NSF 42 and 53 for lead, particulate, chlorine, taste and odor reduction. 3,000 gal. capacity.
- Energy-Savings Feature - allowing for the refrigeration to be powered off when not in use.
- Green Ticker: Informs user of number of 20 oz. plastic water bottles saved from waste.
- Laminar flow provides clean fill with minimal splash.
- Silver Ion Antimicrobial protection on key plastic components to inhibit the growth of mold and mildew.
- Real Drain System eliminates standing water.

PART: _____ QTY: _____

PROJECT: _____

CONTACT: _____

DATE: _____

NOTES: _____

APPROVAL: _____

AMERICAN PRIDE. A LIFETIME TRADITION.
 Like your family, the Elkay family has values and traditions that endure. For almost a century, Elkay has been a family-owned and operated company, providing thousands of jobs that support our families and communities.



Included with Product: Bottle Filler, Water Cooler, Filter

PRODUCT COMPLIANCE

- ADA & ICC A117.1
- ASME A112.19.3/CSA B45.4
- Buy American Act
- CAN/CSA C22.2 No. 120
- GreenSpec®
- NSF/ANSI 42, 53, 81, & 372 (lead free)
- UL 399



Complies with ADA & ICC A117.1 accessibility requirements when installed according to the requirements outlined in these standards. Installation may require additional components and/or construction features to be fully compliant. Consult the local Authority Having Jurisdiction if necessary.

[Installation Instructions \(PDF\)](#)

5 Year Limited Warranty on the refrigeration system of the unit. Electrical components and water system are warranted for 12 months from date of installation. **Warranty pertains to drinking water applications only. Non-drinking water applications are not covered under warranty.**

[Warranty \(PDF\)](#)

OPTIONAL ACCESSORIES

51300C - Elkay WaterSentry Plus Replacement Filter (Bottle Fillers)
WSF6000R-2PK - WaterSentry Fresh 6000 CTO Replacement Filter (2pack)
MLP100 - Accessory - In Wall Carrier (Single) for single EZ, LZ, EMABF, LMABF, VRC, LVRC models
LKAPREZL - Elkay Cane Apron for EZ Gray

In keeping with our policy of continuing product improvement, Elkay reserves the right to change product specifications without notice. Please visit elkay.com for the most current version of Elkay product specification sheets. This specification describes an Elkay product with design, quality, and functional benefits to the user. When making a comparison of other producers' offerings, be certain these features are not overlooked.

Figure 6 - Drinking Fountain specs

EXHIBIT "B-2"
PREMISES DESIGN STANDARDS AND SPECIFICATIONS

3.0 ROOM BY ROOM IMPROVEMENTS & FINISHES

Room Number	Floor	Walls	Comments
100 Waiting	LVT	P1, P2, B2	<ul style="list-style-type: none"> • New suspended ceiling, lighting and HVAC as required per plan. See Sections 1.1, 1.2 and 1.3. • 3 convenience outlets • 2 data/phone receptacles • (1) duplex receptacle and data box at +72" A.F.F. for each video display monitor per plan. • Provide backing for mounting video display monitors. • Entrance doors, office/entry function, keyed separately to grand master hierarchy. Card access system to be installed. See section 1.17. Manufacturer and type to be approved by COUNTY
101 Reception	C1	P1, B1, B2	<ul style="list-style-type: none"> • New suspended ceiling, lighting and HVAC as required per plan. See Sections 1.1, 1.2 and 1.3. • 4 convenience outlets, 2 above counter height • 2 data/phone receptacles, 1 above counter height • Electrical and data outlets located convenient to desk and computer equipment. See Section 1.22. • 1 NEMA type 5-20R receptacles on dedicated circuits.
102 Conference	C1	P1, P2, B2	<ul style="list-style-type: none"> • New lighting and HVAC as required per plan. See Sections 1.1, 1.2 and 1.3. • Provide backing for mounting video display monitors. • 10 convenience outlets • 6 data/phone receptacles • 2 duplex receptacle and data box at +72" A.F.F. for each video display monitor per plan. Provide 2 electrical circuit for floor outlet boxes. Include brass covering flush to flooring surface. Include conduit for data/phone lines to floor outlet box. Location to support furniture plan. • 2 – Glass 4'x6' dry erase boards with tray • 1 – 3'x4' cork board • Lockable door, office/entry function, keyed separately. Card access system to be installed. See Section 1.17.
103 Storage	LVT	P1, B2	<ul style="list-style-type: none"> • New suspended ceiling, lighting and HVAC as required per plan. See Sections 1.1, 1.2 and 1.3. • 2 convenience outlets • 1 data/phone receptacle • Lockable door, office/entry function, keyed separately.

**EXHIBIT “B-2”
PREMISES DESIGN STANDARDS AND SPECIFICATIONS**

104 File Storage	LVT	P1, B2	<ul style="list-style-type: none"> • New suspended ceiling, lighting and HVAC as required per plan. See Sections 1.1, 1.2 and 1.3. • 4 convenience outlets • 2 data/phone receptacles • 1 NEMA type 5-20R receptacles on dedicated circuits. • 1 3’x4 cork board • Lockable door, office/entry function, keyed separately. Card access system to be installed. See Section 1.17.
105 Breakroom	LVT	P4, P2, B2	<ul style="list-style-type: none"> • New suspended ceiling, lighting and HVAC as required per plan. See Sections 1.1, 1.2 and 1.3. • 12 convenience outlets, 4 outlets above counter height, 2 duplex with GFI, 6 dedicated circuits to support appliances. • 2 data/phone receptacles • Approximately 12’ of countertop with upper and base cabinets. Include drawer in base cabinets. All cabinets lockable with wire pulls. Finishes to be selected by COUNTY. • Double sink with garbage disposal. • 2 microwave ovens • 1 commercial coffee maker • 2 refrigerators with ice makers • 2 ceiling fans • 2 – 4’x6’ cork boards • Water fountain • Exhaust vent to outside air. • Door, closer function with safety vision window. • Double 5/8” drywall or other sound mitigation to prevent sound transfer.
106 Wellness Room	LVT & C1	P1, P2, B2	<ul style="list-style-type: none"> • New suspended ceiling, lighting and HVAC as required per plan. See Sections 1.1, 1.2 and 1.3. • 6 convenience outlets, 1 dedicated circuit • 1 refrigerator (Approx. 12cuft) • 2 data/phone receptacles • Lockable door, storeroom function, keyed separately. See Section 1.17.
107 COMM ROOM	VCT	No Paint	<ul style="list-style-type: none"> • Refer to Sections 2.0 through 2.20 for additional information. • Provide plywood backing for mounting equipment to walls. • Provide redundant wall mount HVAC unit. • Lockable door, storeroom function, keyed separately.

**EXHIBIT “B-2”
PREMISES DESIGN STANDARDS AND SPECIFICATIONS**

108 Copy Room	LVT	P1, B2	<ul style="list-style-type: none"> • New suspended ceiling, lighting and HVAC as required per plan. See Sections 1.1, 1.2 and 1.3. • 6 convenience outlets, 2 above counter height • 4 data/phone receptacles, 2 above counter height • 1 NEMA type 5-20R receptacles on dedicated circuits. • 1 – 3’x4’ Cork Board • 2 Lockable doors, 1 office/entry function, keyed separately. 1 exit door, no outer trim for re-entry.
109 Hoteling Office	C1	P1, P2, B2	<ul style="list-style-type: none"> • New suspended ceiling, lighting and HVAC as required per plan. See Sections 1.1, 1.2 and 1.3. • 6 convenience outlets • 3 data/phone receptacles • 1 – 3’x4’ Dry Erase White Board with Trays • 1 – 2’x3’ Cork Board • Lockable door, with safety vision window, office/entry function, keyed separately.
110 – 118, 120 Private Office	C1	P1, P2, B2	<ul style="list-style-type: none"> • New suspended ceiling, lighting and HVAC as required per plan. See Sections 1.1, 1.2 and 1.3. • 6 convenience outlets • 3 data/phone receptacles • 1 – 3’x4’ Dry Erase White Board with Trays • 1 – 2’x3’ Cork Board • Lockable door, with safety vision window, office/entry function, keyed separately.
119 Director Office	C1	P1, P2, B2	<ul style="list-style-type: none"> • New suspended ceiling, lighting and HVAC as required per plan. See Sections 1.1, 1.2 and 1.3. • Provide backing for mounting video display monitors. • 6 convenience outlets • 4 data/phone receptacles • 1 – 3’x4’ Glass Dry Erase White Board with Trays • 1 – 2’x3’ Cork Board • 1 duplex receptacle and data box at +72” A.F.F. for each video display monitor per plan. • Lockable door, with safety vision window, office/entry function, keyed separately.
121 Small Meeting Room	C1	P1, B2	<ul style="list-style-type: none"> • New suspended ceiling, lighting and HVAC as required per plan. See Sections 1.1, 1.2 and 1.3. • 4 convenience outlets • 2 data/phone receptacles • 1 - 4’x6’ Glass Dry Erase White Board • 1 – 2’x3’ Cork Board • Lockable door, with safety vision window, office/entry function, keyed separately.

**EXHIBIT “B-2”
PREMISES DESIGN STANDARDS AND SPECIFICATIONS**

122 Training Room	C1	P1, P2, B2	<ul style="list-style-type: none"> • See Figure 7 – “Proposed Floor Plan” for layout. COUNTY to approve final design before proceeding to working drawings. • New suspended ceiling, lighting and HVAC as required per plan. See Sections 1.1, 1.2 and 1.3. • Provide backing for mounting video display monitors. • 14 convenience outlets • 14 data/phone receptacles • 2 duplex receptacle and data box at +72” A.F.F. for each video display monitor per plan. • 3 - 4’x6’ Glass dry erase boards with tray • 1 - 3’x4’ cork board • Lockable door, with safety vision window, office/entry function, keyed separately.
123 Copy Area	LVT	P1, B2	<ul style="list-style-type: none"> • New suspended ceiling, lighting and HVAC as required per plan. See Sections 1.1, 1.2 and 1.3. • 4 convenience outlets • 2 data/phone receptacles • 1 3’x4’ Cork Board • 1 NEMA type 5-20R receptacles on dedicated circuits.
124 Open Work Area	C1	P1, P3, B2	<ul style="list-style-type: none"> • New suspended ceiling, lighting and HVAC as required per plan. See Sections 1.1, 1.2 and 1.3. • 18 convenience outlets • 18 data/phone receptacles • 5 Ceiling fans • Provide dedicated electrical circuits as required for new modular furniture lay- out. See Section 1.21 for additional information. • Lockable door, with office/entry function and closer, keyed separately. Card access system to be installed. See Section 1.17
125 Closet	LVT	P1, B2	<ul style="list-style-type: none"> • New suspended ceiling, lighting and HVAC as required per plan. See Sections 1.1, 1.2 and 1.3. • Lockable door storeroom function, keyed separately
126 Staff Entrance	LVT	P1, B2	<ul style="list-style-type: none"> • New suspended ceiling, lighting and HVAC as required per plan. See Sections 1.1, 1.2 and 1.3. • 1 convenience outlet • 1 data/phone receptacle • Lockable door with safety vision window office/entry function, keyed separately. Card access system to be installed. See Section 1.17

EXHIBIT "B-2"

PREMISES DESIGN STANDARDS AND SPECIFICATIONS



EXHIBIT "C"

COMMENCEMENT DATE CERTIFICATE

To: _____

Re: Lease Agreement No. _____

In accordance with the terms and conditions of the above referenced Lease, the parties hereby acknowledge and agree to the following:

- 1. The Commencement Date of the Lease Term is _____;
- 2. The Expiration Date of the Lease Term is _____.
- 3. Monthly Rent commenced to accrue on _____, 20____, and the rent schedule during the Lease Term is as follows:

_____ to _____	Monthly Rent of \$_____
_____ to _____	Monthly Rent of \$_____
_____ to _____	Monthly Rent of \$_____
_____ to _____	Monthly Rent of \$_____
_____ to _____	Monthly Rent of \$_____
_____ to _____	Monthly Rent of \$_____
_____ to _____	Monthly Rent of \$_____
_____ to _____	Monthly Rent of \$_____
_____ to _____	Monthly Rent of \$_____

- 4. All other provision and terms of the Lease Agreement, Contract No _____, shall remain the same and are hereby incorporated by reference. In the event of any conflict between the Lease, and this Commencement Date Certificate, the terms and conditions of this Commencement Date Certificate shall control.

LANDLORD:

COUNTY:

Date: _____

Date: _____

EXHIBIT "D"

CUSTODIAL SERVICE REQUIREMENTS

(Janitorial Service to provide/supply all sanitary and paper goods.)

The shift hours scheduled for the Day Janitor are to be reviewed and approved by COUNTY. Following are the services to be performed by a licensed janitorial contractor - Day Janitor:

DAILY SERVICES FIVE (5) DAYS PER WEEK:

1. Empty all waste baskets and other waste containers.
2. Dust mop all tiled/terrazzo floors.
3. Dust all desks, chairs, tables, filing cabinets and other office furniture.
4. Clean and sanitize rest room fixtures, mirrors, chrome pipes, etc.
5. Clean splash marks from walls of rest rooms.
6. Refill soap, towel, and paper containers.
7. Clean and sanitize drinking fountains.
8. Damp clean tabletops in coffee rooms.
9. Clean kitchen sinks and counters.
10. Remove papers and debris outside main entry.

TWICE-MONTHLY SERVICE:

1. Clean lobby directories and fire extinguisher glass.

The following services are to be performed by a licensed janitorial contractor - Evening Janitor:

WEEKLY SERVICE:

1. Wet mop all tiled/terrazzo floors.
2. Clean all desktops that are cleared.
3. Clean hand marks from walls, doors and woodwork.
4. Vacuum all carpeting completely. All carpeted areas are to be vacuumed using a dual motor vacuum with a rotating cylindrical brush, rather than a beater bar.

TWICE-MONTHLY SERVICE:

1. Dust high areas, including window coverings.
2. Machine clean and seal all tiled floors.

EVERY THREE MONTHS:

1. Vacuum dust and dirt accumulation from air conditioning vents.
2. Brush down cobwebs inside building.
3. Replace cartridge in rest room automatic air fresheners.

DAILY SERVICES FIVE (5) DAYS PER WEEK:

1. Empty all waste baskets and other waste containers.
2. Dust mop all tiled/terrazzo floors.
3. Vacuum traffic lanes of carpeting. All carpeted areas are to be vacuumed using a dual motor vacuum with a rotating cylindrical brush, rather than a beater bar.
4. Dust all desks, chairs, tables, filing cabinets and other office furniture.
5. Damp clean lobby counters.
6. Clean and sanitize rest room fixtures, mirrors, chrome pipes, etc.
7. Clean splash marks from walls of rest rooms.
8. Wet mop and sanitize rest room floors.
9. Refill soap, towel, and paper containers.
10. Clean and sanitize drinking fountains.
11. Clean hand marks off glass on entrance doors.

EXHIBIT "D"

CUSTODIAL SERVICE REQUIREMENTS (CONTINUED)

12. Damp clean tabletops in coffee rooms.
13. Clean kitchen sinks and counters.
14. Sweep entryway.
15. Brush down steps of inside stairwells.
16. Vacuum elevator carpet. All carpeted areas are to be vacuumed using a dual motor vacuum with a rotating cylindrical brush, rather than a beater bar.
17. Spot clean all walls and doors including elevator.
18. Spot clean carpets of small spillage, footprints, etc.
19. Keep janitor closets clean and orderly.

The above are considered the minimum standard janitorial items, and are to be performed by a licensed janitorial contractor. Landlord is responsible for providing all services related to the health and cleanliness of the leased facility.

The following services are to be performed by a licensed maintenance contractor.

WEEKLY SERVICE:

1. Replace light bulbs and tubes inside building when needed.

ONCE-MONTHLY SERVICE:

1. Licensed pest control.

EVERY SIX MONTHS:

1. Carpet to be cleaned by a professional carpet cleaning company using hot water extraction process
2. Wash exterior and interior windows and partitions.

EXHIBIT "F"

**FORM OF SUBORDINATION, NON-DISTRUBANCE
AND ATTORNMENT AGREEMENT**

RECORDED AT REQUEST OF
AND TO BE RETURNED TO:

Attn: _____

SUBORDINATION, NONDISTURBANCE AND ATTORNMENT AGREEMENT

THIS SUBORDINATION, NONDISTURBANCE AND ATTORNMENT AGREEMENT ("Agreement") is entered into by and between San Bernardino County ("Tenant"), _____ ("Landlord") and, _____ ("Lender").
(Name and type of entity)

Recitals

A. Landlord, as landlord, and Tenant, as tenant, have entered into a certain Lease Agreement, County Contract No. ____ - ____ dated on _____, 20__ ("Lease") for the lease of certain premises, comprising approximately _____ square feet ("Premises") located at the building with an address of _____, _____, California _____ (zip code), which is situated on certain real property located in the County of San Bernardino, State of California, commonly known as APN _____ ("Property").

B. Landlord represents to County that it has executed and delivered or is about to execute and deliver to Lender a certain promissory note dated substantially contemporaneously herewith ("Note"), in the original principal sum of \$_____. The obligations evidenced by the Note shall be referred to as the "Loan". Landlord further represents to COUNTY that the Note is executed pursuant to the terms of a certain Construction Loan Agreement dated substantially contemporaneously herewith (the "Loan Agreement") between Lender and Landlord.

C. Landlord represents to County that has executed and delivered or is about to execute and deliver to Lender a certain Deed of Trust and Assignment of Rents dated substantially contemporaneously herewith ("Deed of Trust"), encumbering the Property to secure the Loan.

D. Landlord represents that it is a condition precedent to the Loan that the Deed of Trust shall remain at all times a lien upon the Property, prior and superior to the Lease.

E. Landlord represents that it is a condition precedent to the Loan that County will subordinate and subject the Lease, together with all rights and privileges of County thereunder, to the lien of the Deed of Trust.

Covenants

In consideration of the recitals set forth above, which are incorporated herein, and the covenants and agreements contained herein, the parties agree as follows:

1. Subordination: Tenant hereby subordinates all of Tenant's right, title, interest in the leasehold estate of the Premises to the Deed of Trust, subject to the terms of this Agreement.

2. Nondisturbance: Tenant's peaceful and quiet possession of the Premises shall not be disturbed and Tenant's rights and privileges under the Lease, including but not limited to the provisions of the Lease set forth under the headings "TERM," "OPTION TO EXPAND," "OPTION TO EXTEND TERM," "INSURANCE REQUIREMENTS AND SPECIFICATIONS," "DESTRUCTION OF PREMISES," "COUNTY'S EARLY TERMINATION RIGHT," and "CONDEMNATION," shall not be altered or diminished by Lender's foreclosure, acceptance of a deed in lieu of foreclosure, or any other exercise of Lender's rights or remedies under the Deed of Trust, the Note, the Loan Agreement, any other loan document, or the laws governing secured loans. In the event of any conflict among the Lease and the Deed of Trust, the Note, the Loan Agreement, any other loan document, or the laws governing secured loans, the Lease shall prevail. Tenant shall not be named or joined in any foreclosure, trustee's sale, or other proceeding or action to enforce the Deed of Trust, the Note, the Loan Agreement, or any other loan document, unless such joinder shall be legally required to perfect such foreclosure, trustee's sale, or other proceeding or action.

3. Attornment: If the Deed of Trust is foreclosed for any reason, or Landlord deeds the Property to Lender in lieu of foreclosure, the Lease shall not be extinguished and Tenant shall be bound to Lender under all the terms, covenants, and conditions of the Lease for the balance of the Lease Term, including any options to extend thereunder, with the same force and effect as if Lender was the landlord under the Lease. Tenant shall attorn to Lender as Tenant's landlord, and agrees to recognize Lender as the new landlord and promises to pay the Monthly Rent to Lender as landlord. Lender shall assume the interest of Landlord and fulfill all of Landlord's obligations thereunder. This attornment shall be effective and self-operative, without the execution of any other instruments on the part of any of the parties to this Agreement, immediately upon Lender succeeding to the interest of Landlord under the Lease.

4. Disbursements: Lender is under no obligation or duty to monitor the application of the proceeds of the Loan. Any application of such proceeds for purposes other than those provided for in the Loan Agreement or any of the other Loan Documents shall not defeat the effect of this Agreement in whole or in part.

5. Acknowledgment of Assignment: Tenant acknowledges the assignment of Landlord's rights to collect Monthly Rent due under the Lease to Lender pursuant to a certain Assignment of Leases (the "Assignment"). Tenant shall, without duty of inquiry or investigation, pay Monthly Rent to Lender upon receipt of written notice from Lender that Lender has revoked the waiver of Landlord's right to collect the Monthly Rent from the Premises pursuant to the Assignment, notwithstanding the fact that Lender has not foreclosed the Deed of Trust, nor succeeded to the interest of Landlord under the Lease. Landlord hereby releases Tenant and Tenant shall not be liable to Landlord for any payments made to Lender hereunder.

6. Assignment or Sublease: Tenant may assign the Lease or sublease the Premises or any portion thereof in accordance with the Lease, but no such assignment, transfer, or subletting shall relieve Tenant of any of its obligations under the Lease.

7. Notices: Any notice, demand, request, consent, approval or communication that either party desires or is required to give to the other party, or any other person shall be in writing and either served personally, delivered by a reputable overnight courier service, or sent by postage prepaid, first-class United States mail, certified or registered, return receipt requested. Any notice, demand, request, consent, approval or communication that either party desires or is required to give to the other party shall be addressed to the other party at the addresses set forth in the Basic Lease Provisions. Either party may change its address by notifying the other party of the change of address. Notices shall be deemed delivered upon the earlier of: (i) actual receipt

if such notice is personally delivered on a COUNTY business day; (ii) the date of delivery if such notice is delivered by a reputable overnight courier service on a COUNTY business day; otherwise on the next COUNTY business day; or (iii) the date of delivery or refusal of the addressee to accept delivery if such notice is sent by postage pre-paid, first-class United States mail, certified or registered, return receipt requested, if on a COUNTY business day; otherwise on the next COUNTY business day:

to Tenant: San Bernardino County
Attn: Director, Real Estate Services Department
385 North Arrowhead Avenue, Third Floor
San Bernardino, California 92415-0180

to Landlord: _____

Attn: _____

to Lender: _____

Attn: _____

Notwithstanding the foregoing, any notice under or pertaining to this Agreement, given and effective in accordance with applicable law, shall be effective for purposes hereof. Any party may change the address at which it is to receive notices hereunder to another business address within the United States (but not a post office box or similar mail receptacle) by giving notice of such change of address in accordance herewith.

8. Landlord's Default: Tenant hereby agrees that Tenant will notify Lender in writing, in accordance with Paragraph 7, Notices, above, of any default by Landlord under the terms of the Lease, provided that Lender shall have the same time period as Landlord is given under the Lease to remedy a remedy.

9. Binding Effect: This Agreement is binding upon and inures to the benefit of the Parties and their respective successors, assigns, heirs, executors, and administrators.

10 Attorneys' Fees and Costs: If any legal action is instituted to enforce or declare a party's rights hereunder, each party, including the prevailing party, must bear its own attorneys' fees and costs. This paragraph shall not apply to those attorneys' fees and costs directly arising from any third party legal action against COUNTY, including such attorneys' fees and costs payable under Paragraph 19, INDEMNIFICATION, Paragraph 13, HAZARDOUS SUBSTANCES, Paragraph 31 PUBLIC RECORDS DISCLOSURE, and Paragraph 32, CONFIDENTIALITY of the Lease.

11. Law: This Agreement shall be governed by and construed in accordance with the laws of the State of California.

12. Venue: The parties acknowledge and agree that the Agreement was entered into and intended to be performed in the County of San Bernardino, California. The parties agree that the venue for any action or

claim brought by any party to the Lease will be the Superior Court of California, County of San Bernardino. Each party hereby waives any law, statute (including but not limited to Code of Civil Procedure section 394), or rule of court that would allow them to request or demand a change of venue. If any third party brings an action or claim concerning the Lease, the parties hereto agree to use their best efforts to obtain a change of venue to the Superior Court of California, County of San Bernardino.

IN WITNESS WHEREOF, the parties have executed this Agreement as of the day and year written below.

LANDLORD:

COUNTY:

Date: _____

Date: _____

EXHIBIT "G"

LIST OF FORMER COUNTY OFFICIALS

INSTRUCTIONS: List the full names of former COUNTY Administrative Officials, the title/description of the Official's last position with COUNTY, the date the Official terminated COUNTY employment, the Official's current employment and/or representative capacity with LANDLORD, and the date the Official entered LANDLORD's employment and/or representation.

OFFICIAL'S NAME: REQUIRED INFORMATION

LANDLORD hereby certifies the information it has provided in this Exhibit "G" is true, complete, and accurate.

LANDLORD:

By: _____
(Name)

Title: _____

Date: _____

EXHIBIT "H"
PREVAILING WAGE REQUIREMENTS

A. In the event all or a portion of the Scope of Work in the Contract requires the payment of prevailing wages as required by California state law, and compliance with the following requirements:

1. Determination of Prevailing Rates:

Pursuant to Labor Code sections 1770, et seq., the County has obtained from the Director of the Department of Industrial Relations (DIR) pursuant to the California Labor Code, the general prevailing rates of per diem wages and the prevailing rates for holiday and overtime work in the locality in which the Scope of Work is to be performed. Copies of said rates are on file with the County, will be made available for inspection during regular business hours, may be included elsewhere in the specifications for the Scope of Work, and are also available online at www.dir.ca.gov. The wage rate for any classification not listed, but which may be required to execute the Scope of Work, shall be commensurate and in accord with specified rates for similar or comparable classifications for those performing similar or comparable duties. In accordance with Labor Code section 1773.2, the Contractor shall post, at appropriate and conspicuous locations on the job site, a schedule showing all applicable prevailing wage rates and shall comply with the requirements of Labor Code sections 1773, et seq.

2. Payment of Prevailing Rates

Each worker of the Contractor, or any subcontractor, engaged in the Scope of Work, shall be paid not less than the general prevailing wage rate, regardless of any contractual relationship which may be alleged to exist between the Contractor or any subcontractor, and such worker.

3. Prevailing Rate Penalty

The Contractor shall, as a penalty, forfeit two hundred dollars (\$200.00) to the County for each calendar day or portion thereof, for each worker paid less than the prevailing rates as determined by the Director of the DIR for such work or craft in which such worker is employed by the Contractor or by any subcontractor in connection with the Scope of Work. Pursuant to California Labor Code section 1775, the difference between such prevailing wage rates and the amount paid to each worker for each calendar day, or portion thereof, for which each worker was paid less than the prevailing wage rate, shall be paid to each worker by the Contractor.

4. Ineligible Contractors:

Pursuant to the provisions of Labor Code section 1777.1, the Labor Commissioner publishes and distributes a list of contractors ineligible to perform work as a contractor or subcontractor on a public works project. This list of debarred contractors is available from the DIR website at <http://www.dir.ca.gov/Public-Works/PublicWorks.html>. Any contract entered into between a contractor and a debarred subcontractor is void as a matter of law. A debarred subcontractor may not receive any public money for performing work as a subcontractor on a public works contract, and any public money that may have been paid to a debarred subcontractor by a contractor on the project shall be returned to the County. The Contractor shall be responsible for the payment of wages to workers as a debarred subcontractor who has been allowed to work on the Scope of Work.

5. Payroll Records:

a. Pursuant to California Labor Code section 1776, the Contractor and each subcontractor, shall keep accurate certified payroll records, showing the name, address, social security number, work classification, straight time and overtime hours worked each day and week, and the actual per diem wages paid to each journeyman, apprentice, worker or other employee employed by them in connection with the Scope of Work. The payroll records enumerated herein shall be verified by a written declaration made under penalty of perjury that the information contained in the payroll record is true and correct and that the Contractor or subcontractor has complied with the requirements of the California Labor Code sections 1771, 1811, and 1815 for any Scope of Work performed by his or her employees. The payroll records shall be available for inspection at all reasonable hours at the principal office of the Contractor on the following basis:

- i. A certified copy of an employee's payroll record shall be made available for inspection or furnished to such employee or his/her authorized representative on request;
- ii. A certified copy of all payroll records shall be made available for inspection or furnished upon request to the County, the Division of Labor Standards Enforcement of the DIR;
- iii. A certified copy of payroll records shall be made available upon request to the public for inspection or copies thereof made; provided, however, that a request by the public shall be made through either the County or the Division of Labor Standards Enforcement. If the requested payroll records have not been previously provided to the County or the Division of Labor Standards Enforcement, the requesting party shall, prior to being provided the records, reimburse the cost of preparation by

the Contractor, subcontractor and the entity through which the request was made; the public shall not be given access to such records at the principal office of the Contractor;

- iv. The Contractor shall file a certified copy of the payroll records with the entity that requested such records within ten (10) days after receipt of a written request; and
 - v. Copies provided to the public, by the County or the Division of Labor Standards Enforcement shall be marked or obliterated in such a manner as to prevent disclosure of an individual's name, address and social security number. The name and address of the Contractor or any subcontractor, performing a part of the Scope of Work shall not be marked or obliterated. The Contractor shall inform the County of the location of payroll records, including the street address, city and county and shall, within five (5) working days, provide a notice of a change of location and address.
- b. The Contractor shall have ten (10) days from receipt of the written notice specifying in what respects the Contractor must comply with the above requirements. In the event Contractor does not comply with the requirements of this section within the ten (10) day period, the Contractor shall, as a penalty to the County, forfeit one-hundred dollars (\$100.00) for each calendar day, or portion thereof, for each worker, until strict compliance is effectuated. Upon the request of the Division of Labor Standards Enforcement, such penalty shall be withheld from any portion of the payments then due or to become due to the Contractor.

6. Limits on Hours of Work:

Pursuant to California Labor Code section 1810, eight (8) hours of labor shall constitute a legal day's work. Pursuant to California Labor Code section 1811, the time of service of any worker employed at any time by the Contractor or by a subcontractor, upon the Scope of Work or upon any part of the Scope of Work, is limited and restricted to eight (8) hours during any one calendar day and forty (40) hours during any one calendar week, except as provided for under Labor Code section 1815. Notwithstanding the foregoing provisions, work performed by employees of Contractor or any subcontractor, in excess of eight (8) hours per day and forty (40) hours during any one week, shall be permitted upon compensation for all hours worked in excess of eight (8) hours per day at not less than one and one-half (1½) times the basic rate of pay.

7. Penalty for Excess Hours:

The Contractor shall pay to the County a penalty of twenty-five dollars (\$25.00) for each worker employed on the Scope of Work by the Contractor or any subcontractor, for each calendar day during which such worker is required or permitted to work more than eight (8) hours in any calendar day and forty (40) hours in any one calendar week, in violation of the provisions of the California Labor Code, unless compensation to the worker so employed by the Contractor is not less than one and one-half (1½) times the basic rate of pay for all hours worked in excess of eight (8) hours per day.

8. Senate Bill 854 (Chapter 28, Statutes of 2014) and Senate Bill 96 (Chapter 28, Statutes of 2017) Requirements:

- a. Contractor shall comply with Senate Bill 854 and Senate Bill 96. The requirements include, but are not limited to, the following:
 - i. No contractor or subcontractor may be listed on a bid proposal for a public works project unless registered with the DIR pursuant to Labor Code section 1725.5, with limited exceptions from this requirements for bid purposes only as allowed under Labor Code section 1771.1(a).
 - ii. No contractor or subcontractor may be awarded a contract for public work or perform work on a public works project unless registered with the DIR pursuant to Labor Code section 1725.5.
 - iii. This project is subject to compliance monitoring and enforcement by the DIR.
 - iv. As required by the DIR, Contractor is required to post job site notices, as prescribed by regulation, regarding compliance monitoring and enforcement by the DIR.
 - v. Contractors and all subcontractors must submit certified payroll records online to the Labor Commissioner for all public works projects.
 - 1) The certified payroll must be submitted at least monthly to the Labor Commissioner.
 - 2) The County reserves the right to require Contractor and all subcontractors to submit certified payroll records more frequently than monthly to the Labor Commissioner.
 - 3) The certified payroll records must be in a format prescribed by the Labor Commissioner.
 - vi. Registration with the DIR and the submission of certified payroll records to the Labor Commissioner are not required if the public works project is \$25,000 or less when the project is for construction, alteration, demolition, installation or repair work, or if the public works project is \$15,000 or less when the project is for maintenance work.

b. Labor Code section 1725.5 states the following:

“A contractor shall be registered pursuant to this section to be qualified to bid on, be listed in a bid proposal, subject to the requirements of Section 4104 of the Public Contract Code, or engage in the performance of any public work contract that is subject to the requirements of this chapter. For the purposes of this section, “contractor” includes a subcontractor as defined by Section 1722.1.

(a) To qualify for registration under this section, a contractor shall do all of the following:

(1) (A) Register with the Department of Industrial Relations in the manner prescribed by the department and pay an initial nonrefundable application fee of four hundred dollars (\$400) to qualify for registration under this section and an annual renewal fee on or before July 1 of each year thereafter. The annual renewal fee shall be in a uniform amount set by the Director of Industrial Relations, and the initial registration and renewal fees may be adjusted no more than annually by the director to support the costs specified in Section 1771.3.

(B) Beginning June 1, 2019, a contractor may register or renew according to this subdivision in annual increments up to three years from the date of registration. Contractors who wish to do so will be required to prepay the applicable nonrefundable application or renewal fees to qualify for the number of years for which they wish to preregister.

(2) Provide evidence, disclosures, or releases as are necessary to establish all of the following:

(A) Workers' compensation coverage that meets the requirements of Division 4 (commencing with Section 3200) and includes sufficient coverage for any worker whom the contractor employs to perform work that is subject to prevailing wage requirements other than a contractor who is separately registered under this section. Coverage may be evidenced by a current and valid certificate of workers' compensation insurance or certification of self-insurance required under Section 7125 of the Business and Professions Code.

(B) If applicable, the contractor is licensed in accordance with Chapter 9 (commencing with Section 7000) of the Business and Professions Code.

(C) The contractor does not have any delinquent liability to an employee or the state for any assessment of back wages or related damages, interest, fines, or penalties pursuant to any final judgment, order, or determination by a court or any federal, state, or local administrative agency, including a confirmed arbitration award. However, for purposes of this paragraph, the contractor shall not be disqualified for any judgment, order, or determination that is under appeal, provided that the contractor has secured the payment of any amount eventually found due through a bond or other appropriate means.

(D) The contractor is not currently debarred under Section 1777.1 or under any other federal or state law providing for the debarment of contractors from public works.

(E) The contractor has not bid on a public works contract, been listed in a bid proposal, or engaged in the performance of a contract for public works without being lawfully registered in accordance with this section, within the preceding 12 months or since the effective date of the requirements set forth in subdivision (e), whichever is earlier. If a contractor is found to be in violation of the requirements of this paragraph, the period of disqualification shall be waived if both of the following are true:

(i) The contractor has not previously been found to be in violation of the requirements of this paragraph within the preceding 12 months.

(ii) The contractor pays an additional nonrefundable penalty registration fee of two thousand dollars (\$2,000).

(b) Fees received pursuant to this section shall be deposited in the State Public Works Enforcement Fund established by Section 1771.3 and shall be used only for the purposes specified in that section.

(c) A contractor who fails to pay the renewal fee required under paragraph (1) of subdivision (a) on or before the expiration of any prior period of registration shall be prohibited from bidding on or engaging in the performance of any contract for public work until once again registered pursuant to this section. If the failure to pay the renewal fee was inadvertent, the contractor may renew its registration retroactively by paying an additional nonrefundable penalty renewal fee equal to the amount of the renewal fee within 90 days of the due date of the renewal fee.

(d) If, after a body awarding a contract accepts the contractor's bid or awards the contract, the work covered by the bid or contract is determined to be a public work to which Section 1771 applies, either as the result of a determination by the director pursuant to Section 1773.5 or a court decision, the requirements of this section shall not apply, subject to the following requirements:

(1) The body that awarded the contract failed, in the bid specification or in the contract documents, to identify as a public work that portion of the work that the determination or decision subsequently classifies as a public work.

(2) Within 20 days following service of notice on the awarding body of a determination by the Director of Industrial Relations pursuant to Section 1773.5 or a decision by a court that the contract was for public work as defined in this chapter, the contractor and any subcontractors are registered under this section or are replaced by a contractor or subcontractors who are registered under this section.

(3) The requirements of this section shall apply prospectively only to any subsequent bid, bid proposal, contract, or work performed after the awarding body is served with notice of the determination or decision referred to in paragraph (2).

(e) The requirements of this section shall apply to any bid proposal submitted on or after March 1, 2015, to any contract for public work, as defined in this chapter, executed on or after April 1, 2015, and to any work performed under a contract for public work on or after January 1, 2018, regardless of when the contract for public work was executed.

(f) This section does not apply to work performed on a public works project of twenty-five thousand dollars (\$25,000) or less when the project is for construction, alteration, demolition, installation, or repair work or to work performed on a public works project of fifteen thousand dollars (\$15,000) or less when the project is for maintenance work.”

c. Labor Code section 1771.1 states the following:

“(a) A contractor or subcontractor shall not be qualified to bid on, be listed in a bid proposal, subject to the requirements of Section 4104 of the Public Contract Code, or engage in the performance of any contract for public work, as defined in this chapter, unless currently registered and qualified to perform public work pursuant to Section 1725.5. It is not a violation of this section for an unregistered contractor to submit a bid that is authorized by Section 7029.1 of the Business and Professions Code or by Section 10164 or 20103.5 of the Public Contract Code, provided the contractor is registered to perform public work pursuant to Section 1725.5 at the time the contract is awarded.

(b) Notice of the requirement described in subdivision (a) shall be included in all bid invitations and public works contracts, and a bid shall not be accepted nor any contract or subcontract entered into without proof of the contractor or subcontractor's current registration to perform public work pursuant to Section 1725.5.

(c) An inadvertent error in listing a subcontractor who is not registered pursuant to Section 1725.5 in a bid proposal shall not be grounds for filing a bid protest or grounds for considering the bid nonresponsive, provided that any of the following apply:

(1) The subcontractor is registered prior to the bid opening.

(2) Within 24 hours after the bid opening, the subcontractor is registered and has paid the penalty registration fee specified in subparagraph (E) of paragraph (2) of subdivision (a) of Section 1725.5.

(3) The subcontractor is replaced by another registered subcontractor pursuant to Section 4107 of the Public Contract Code.

(d) Failure by a subcontractor to be registered to perform public work as required by subdivision (a) shall be grounds under Section 4107 of the Public Contract Code for the contractor, with the consent of the awarding authority, to substitute a subcontractor who is registered to perform public work pursuant to Section 1725.5 in place of the unregistered subcontractor.

(e) The department shall maintain on its Internet Web site a list of contractors who are currently registered to perform public work pursuant to Section 1725.5.

(f) A contract entered into with any contractor or subcontractor in violation of subdivision (a) shall be subject to cancellation, provided that a contract for public work shall not be unlawful, void, or voidable solely due to the failure of the awarding body, contractor, or any subcontractor to comply with the requirements of Section 1725.5 or this section.

(g) If the Labor Commissioner or his or her designee determines that a contractor or subcontractor engaged in the performance of any public work contract without having been registered in accordance with this section, the contractor or subcontractor shall forfeit, as a civil penalty to the state, one hundred dollars (\$100) for each day of work performed in violation of the registration requirement, not to exceed an aggregate penalty of eight thousand dollars (\$8,000) in addition to any penalty registration fee assessed pursuant to clause (ii) of subparagraph (E) of paragraph (2) of subdivision (a) of Section 1725.5.

(h)(1) In addition to, or in lieu of, any other penalty or sanction authorized pursuant to this chapter, a higher tiered public works contractor or subcontractor who is found to have entered into a subcontract with an unregistered lower tier subcontractor to perform any public work in violation of the requirements of Section 1725.5 or this section shall be subject to forfeiture, as a civil penalty to the state, of one hundred dollars

(\$100) for each day the unregistered lower tier subcontractor performs work in violation of the registration requirement, not to exceed an aggregate penalty of ten thousand dollars (\$10,000).

(2) The Labor Commissioner shall use the same standards specified in subparagraph (A) of paragraph (2) of subdivision (a) of Section 1775 when determining the severity of the violation and what penalty to assess, and may waive the penalty for a first time violation that was unintentional and did not hinder the Labor Commissioner's ability to monitor and enforce compliance with the requirements of this chapter.

(3) A higher tiered public works contractor or subcontractor shall not be liable for penalties assessed pursuant to paragraph (1) if the lower tier subcontractor's performance is in violation of the requirements of Section 1725.5 due to the revocation of a previously approved registration.

(4) A subcontractor shall not be liable for any penalties assessed against a higher tiered public works contractor or subcontractor pursuant to paragraph (1). A higher tiered public works contractor or subcontractor may not require a lower tiered subcontractor to indemnify or otherwise be liable for any penalties pursuant to paragraph (1).

(i) The Labor Commissioner or his or her designee shall issue a civil wage and penalty assessment, in accordance with the provisions of Section 1741, upon determination of penalties pursuant to subdivision (g) and subparagraph (B) of paragraph (1) of subdivision (h). Review of a civil wage and penalty assessment issued under this subdivision may be requested in accordance with the provisions of Section 1742. The regulations of the Director of Industrial Relations, which govern proceedings for review of civil wage and penalty assessments and the withholding of contract payments under Article 1 (commencing with Section 1720) and Article 2 (commencing with Section 1770), shall apply.

(j)(1) Where a contractor or subcontractor engages in the performance of any public work contract without having been registered in violation of the requirements of Section 1725.5 or this section, the Labor Commissioner shall issue and serve a stop order prohibiting the use of the unregistered contractor or the unregistered subcontractor on all public works until the unregistered contractor or unregistered subcontractor is registered. The stop order shall not apply to work by registered contractors or subcontractors on the public work.

(2) A stop order may be personally served upon the contractor or subcontractor by either of the following methods:

(A) Manual delivery of the order to the contractor or subcontractor personally.

(B) Leaving signed copies of the order with the person who is apparently in charge at the site of the public work and by thereafter mailing copies of the order by first class mail, postage prepaid to the contractor or subcontractor at one of the following:

(i) The address of the contractor or subcontractor on file with either the Secretary of State or the Contractors' State License Board.

(ii) If the contractor or subcontractor has no address on file with the Secretary of State or the Contractors' State License Board, the address of the site of the public work.

(3) The stop order shall be effective immediately upon service and shall be subject to appeal by the party contracting with the unregistered contractor or subcontractor, by the unregistered contractor or subcontractor, or both. The appeal, hearing, and any further review of the hearing decision shall be governed by the procedures, time limits, and other requirements specified in subdivision (a) of Section 238.1.

(4) Any employee of an unregistered contractor or subcontractor who is affected by a work stoppage ordered by the commissioner pursuant to this subdivision shall be paid at his or her regular hourly prevailing wage rate by that employer for any hours the employee would have worked but for the work stoppage, not to exceed 10 days.

(k) Failure of a contractor or subcontractor, owner, director, officer, or managing agent of the contractor or subcontractor to observe a stop order issued and served upon him or her pursuant to subdivision (j) is guilty of a misdemeanor punishable by imprisonment in county jail not exceeding 60 days or by a fine not exceeding ten thousand dollars (\$10,000), or both.

(l) This section shall apply to any bid proposal submitted on or after March 1, 2015, and any contract for public work entered into on or after April 1, 2015. This section shall also apply to the performance of any public work, as defined in this chapter, on or after January 1, 2018, regardless of when the contract for public work was entered.

(m) Penalties received pursuant to this section shall be deposited in the State Public Works Enforcement Fund established by Section 1771.3 and shall be used only for the purposes specified in that section.

(n) This section shall not apply to work performed on a public works project of twenty-five thousand dollars (\$25,000) or less when the project is for construction, alteration, demolition, installation, or repair work or to work performed on a public works project of fifteen thousand dollars (\$15,000) or less when the project is for maintenance work."

d. Labor Code section 1771.4 states the following:

“a) All of the following are applicable to all public works projects that are otherwise subject to the requirements of this chapter:

(1) The call for bids and contract documents shall specify that the project is subject to compliance monitoring and enforcement by the Department of Industrial Relations.

(2) The awarding body shall post or require the prime contractor to post job site notices, as prescribed by regulation.

(3) Each contractor and subcontractor shall furnish the records specified in Section 1776 directly to the Labor Commissioner, in the following manner:

(A) At least monthly or more frequently if specified in the contract with the awarding body.

(B) In a format prescribed by the Labor Commissioner.

(4) If the contractor or subcontractor is not registered pursuant to Section 1725.5 and is performing work on a project for which registration is not required because of subdivision (f) of Section 1725.5, the unregistered contractor or subcontractor is not required to furnish the records specified in Section 1776 directly to the Labor Commissioner but shall retain the records specified in Section 1776 for at least three years after completion of the work.

(5) The department shall undertake those activities it deems necessary to monitor and enforce compliance with prevailing wage requirements.

(b) The Labor Commissioner may exempt a public works project from compliance with all or part of the requirements of subdivision (a) if either of the following occurs:

(1) The awarding body has enforced an approved labor compliance program, as defined in Section 1771.5, on all public works projects under its authority, except those deemed exempt pursuant to subdivision (a) of Section 1771.5, continuously since December 31, 2011.

(2) The awarding body has entered into a collective bargaining agreement that binds all contractors performing work on the project and that includes a mechanism for resolving disputes about the payment of wages.

(c) The requirements of paragraph (1) of subdivision (a) shall only apply to contracts for public works projects awarded on or after January 1, 2015.

(d) The requirements of paragraph (3) of subdivision (a) shall apply to all contracts for public work, whether new or ongoing, on or after January 1, 2016.”

B. STATE PUBLIC WORKS APPRENTICESHIP REQUIREMENTS

1. State Public Works Apprenticeship Requirements:

a. The Contractor is responsible for compliance with Labor Code section 1777.5 and the California Code of Regulations, title 8, sections 230 – 230.2 for all apprenticeable occupations (denoted with “#” symbol next to craft name in DIR Prevailing Wage Determination), whether employed by the Contractor, subcontractor, vendor or consultant. Included in these requirements is (1) the Contractor’s requirement to provide notification (i.e. DAS-140) to the appropriate apprenticeship committees; (2) pay training fund contributions for each apprenticeable hour employed on the Contract; and (3) utilize apprentices in a minimum ratio of not less than one apprentice hour for each five journeyman hours by completion of Contract work (unless an exception is granted in accordance with Labor Code section 1777.5) or request for the dispatch of apprentices.

b. Any apprentices employed to perform any of the Scope of Work shall be paid the standard wage to apprentices under the regulations of the craft or trade for which such apprentice is employed, and such individual shall be employed only for the work of the craft or trade to which such individual is registered. Only apprentices, as defined in California Labor Code section 3077, who are in training under apprenticeship standards and written apprenticeship agreements under California Labor Code sections 3070 et seq. are eligible to be employed for the Scope of Work. The employment and training of each apprentice shall be in accordance with the provisions of the apprenticeship standards and apprentice agreements under which such apprentice is training.

2. Compliance with [California Labor Code section 1777.5](#) requires all public works contractors to:

a. Submit Contract Award Information (DAS-140):

- i. Although there are a few exemptions (identified below), all Contractors, regardless of union affiliation, must submit contract award information when performing on a California public works project.
 - ii. The DAS-140 is a notification “announcement” of the Contractor’s participation on a public works project—*it is not a request for the dispatch of an apprentice.*
 - iii. Contractors shall submit the contract award information (you may use form DAS 140) within 10 days of the execution of the prime contract or subcontract, but in no event later than the first day in which the Contractor has workers employed on the public work.
 - iv. Contractors who are already approved to train apprentices (i.e. check “Box 1” on the DAS-140) shall only be required to submit the form to their approved program.
 - v. Contractors who are NOT approved to train apprentices (i.e. those that check either “Box 2” or “Box 3” on the DAS-140) shall submit the DAS-140 TO EACH of the apprenticeship program sponsors in the area of your public works project. For a listing of apprenticeship programs see <http://www.dir.ca.gov/Databases/das/pwaddrstart.asp>.
- b. Employ Registered Apprentices
- i. Labor Code section 1777.5 requires that a contractor performing work in an “apprenticeable” craft must employ one (1) hour of apprentice work for every five (5) hours performed by a journeyman. This ratio shall be met prior to the Contractor’s completion of work on the project. “Apprenticeable” crafts are denoted with a pound symbol “#” in front of the craft name on the prevailing wage determination.
 - ii. All Contractors who do not fall within an exemption category (see below) must request for dispatch of an apprentice from an apprenticeship program (for each apprenticeable craft or trade) by giving the program actual notice of at least 72 hours (business days only) before the date on which apprentices are required.
 - iii. Contractors may use the “DAS-142” form for making a request for the dispatch of an apprentice.
 - iv. Contractors who are participating in an approved apprenticeship training program and who did not receive sufficient number of apprentices from their initial request must request dispatch of apprentices from ALL OTHER apprenticeship committees in the project area in order to fulfill this requirement.
 - v. Contractor should maintain and submit proof (when requested) of its DAS-142 submittal to the apprenticeship committees (e.g. fax transmittal confirmation). A Contractor has met its requirement to employ apprentices only after it has successfully made a dispatch request to all apprenticeship programs in the project area.
 - vi. Only “registered” apprentices may be paid the prevailing apprentice rates and must, at all times work under the supervision of a Journeyman (Cal. Code Regs., tit 8, § 230.1).
- c. Make Training Fund Contributions
- i. Contractors performing in apprenticeable crafts on public works projects, must make training fund contributions in the amount established in the prevailing wage rate publication for journeymen and apprentices.
 - ii. Contractors may use the “CAC-2” form for submittal of their training fund contributions.
 - iii. Contractors who do not submit their training fund contributions to an approved apprenticeship training program must submit their contributions to the California Apprenticeship Council (CAC), PO Box 420603, San Francisco, CA 94142-0603.
 - iv. Training fund contributions to the CAC are due and payable on the 15th day of the month for work performed during the preceding month.
 - v. The “training” contribution amount identified on the prevailing wage determination shall not be paid to the worker, unless the worker falls within one of the exemption categories listed below.

3. Exemptions to Apprenticeship Requirements:

- a. The following are exempt from having to comply with California apprenticeship requirements. These types of contractors do not need to submit a DAS-140, DAS-142, make training fund contributions, or utilize apprentices:
 - i. When the Contractor holds a sole proprietor license (“Owner-Operator”) and no workers were employed by the Contractor. In other words, the contractor performed the entire work from start to finish and worked alone.
 - ii. Contractors performing in non-apprenticeable crafts. “Apprenticeable” crafts are denoted with a pound symbol “#” in front of the craft name on the prevailing wage determination.

- iii. When the Contractor has a direct contract with the Public Agency that is under \$30,000.
- iv. When the project is 100% federally-funded and the funding of the project does not contain any city, county, and/or state monies (unless the project is administered by a state agency in which case the apprenticeship requirements apply).
- v. When the project is a private project not covered by the definition of public works as found in Labor Code section 1720.

4. Exemption from Apprenticeship Ratios:

- a. The Joint Apprenticeship Committee shall have the discretion to grant a certificate, which shall be subject to the approval of the Administrator of Apprenticeship, exempting the Contractor from the 1-to-5 ratio set forth in this Section when it finds that any one of the following conditions are met:
 - i. Unemployment for the previous three-month period in such area exceeds an average of fifteen percent (15%); or
 - ii. The number of apprentices in training in such area exceeds a ratio of 1-to-5 in relation to journeymen; or
 - iii. The Apprenticeable Craft or Trade is replacing at least one-thirtieth (1/30) of its journeymen annually through apprenticeship training, either on a statewide basis or on a local basis; or
 - iv. If assignment of an apprentice to any work performed under the Contract Documents would create a condition which would jeopardize such apprentice's life or the life, safety or property of fellow employees or the public at large, or if the specific task to which the apprentice is to be assigned is of such a nature that training cannot be provided by a journeyman.
- b. When such exemptions from the 1-to-5 ratio between apprentices and journeymen are granted to an organization which represents contractors in a specific trade on a local or statewide basis, the member contractors will not be required to submit individual applications for approval to local Joint Apprenticeship Committees, provided they are already covered by the local apprenticeship standards.

5. Contractor's Compliance:

- a. The responsibility of compliance with this Section for all Apprenticeable Trades or Crafts is solely and exclusively that of the Contractor. All decisions of the Joint Apprenticeship Committee(s) under this Section are subject to the provisions of California Labor Code section 3081 and penalties are pursuant to Labor Code section 1777.7 and the determination of the Labor Commissioner.



EXHIBIT "I"
Campaign Contribution Disclosure
(SB 1439)

DEFINITIONS

Actively supporting the matter: (a) Communicate directly with a member of the Board of Supervisors or other County elected officer [Sheriff, Assessor-Recorder-Clerk, District Attorney, Auditor-Controller/Treasurer/Tax Collector] for the purpose of influencing the decision on the matter; or (b) testifies or makes an oral statement before the County in a proceeding on the matter for the purpose of influencing the County's decision on the matter; or (c) communicates with County employees, for the purpose of influencing the County's decision on the matter; or (d) when the person/company's agent lobbies in person, testifies in person or otherwise communicates with the Board or County employees for purposes of influencing the County's decision in a matter.

Agent: A third-party individual or firm who, for compensation, is representing a party or a participant in the matter submitted to the Board of Supervisors. If an agent is an employee or member of a third-party law, architectural, engineering or consulting firm, or a similar entity, both the entity and the individual are considered agents.

Otherwise related entity: An otherwise related entity is any for-profit organization/company which does not have a parent-subsidary relationship but meets one of the following criteria:

- (1) One business entity has a controlling ownership interest in the other business entity;
- (2) there is shared management and control between the entities; or
- (3) a controlling owner (50% or greater interest as a shareholder or as a general partner) in one entity also is a controlling owner in the other entity.

For purposes of (2), "shared management and control" can be found when the same person or substantially the same persons own and manage the two entities; there are common or commingled funds or assets; the business entities share the use of the same offices or employees, or otherwise share activities, resources or personnel on a regular basis; or there is otherwise a regular and close working relationship between the entities.

Parent-Subsidiary Relationship: A parent-subsidiary relationship exists when one corporation has more than 50 percent of the voting power of another corporation.

Landlord must respond to the questions on the following page. If a question does not apply respond N/A or Not Applicable.

1. Name of Landlord:
 1250 FAIRFAX LLC, a California limited liability company, and
 521 EAST 11th St. LLC, a California limited liability company

2. Is the entity listed in Question No. 1 a non-profit organization under Internal Revenue Code section 501(c)(3)?
 Yes If yes, skip Question Nos. 3 - 4 and go to Question No. 5.
 No

3. Name of Principal (i.e., CEO/President) of entity listed in Question No. 1, if the individual actively supports the matter and has a financial interest in the decision:
 Robert Hanasab

4. If the entity identified in Question No.1 is a corporation held by 35 or less shareholders, and not publicly traded ("closed corporation"), identify the major shareholder(s):
 Not Applicable

5. Name of any parent, subsidiary, or otherwise related entity for the entity listed in Question No. 1 (see definitions above):

Company Name	Relationship
Not Applicable	

6. Name of agent(s) of Landlord:

Company Name	Agent(s)	Date Agent Retained (if less than 12 months prior)
Not Applicable		

7. Name of Subcontractor(s) (including Principal and Agent(s)) that will be providing services/work under the awarded contract if the subcontractor (1) actively supports the matter and (2) has a financial interest in the decision and (3) will be possibly identified in the contract with the County or board governed special district:

Company Name	Subcontractor(s):	Principal and/or Agent(s):
Not Applicable		

8. Name of any known individuals/companies who are not listed in Questions 1-7, but who may (1) actively support or oppose the matter submitted to the Board and (2) have a financial interest in the outcome of the decision:

Company Name	Individual(s) Name
Not Applicable	

9. Was a campaign contribution, of more than \$250, made to any member of the San Bernardino County Board of Supervisors or other County elected officer within the prior 12 months, by any of the individuals or entities listed in Question Nos. 1-8?

No If no, please skip Question No. 10. Yes If yes, please continue to complete this form.

10. Name of Board of Supervisor Member or other County elected officer: Not Applicable

Name of Contributor: _____

Date(s) of Contribution(s): _____

Amount(s): _____

Please add an additional sheet(s) to identify additional Board Members or other County elected officers to whom anyone listed made campaign contributions.

By signing below, Landlord certifies that the statements made herein are true and correct. Landlord understands that the individuals and entities listed in Question Nos. 1-8 are prohibited from making campaign contributions of more than \$250 to any member of the Board of Supervisors or other County elected officer while this matter is pending and for 12 months after a final decision is made by the County.

Robert Hanasab
Signature

Robert Hanasab

Print Name

6/27/2024

Date

1250 FAIRFAX LLC, a California limited liability company, and
521 EAST 11th St. LLC, a California limited liability company

Print Entity Name, if applicable